

RAYMOND

STATION AREA PLAN



Adopted October 22, 2008



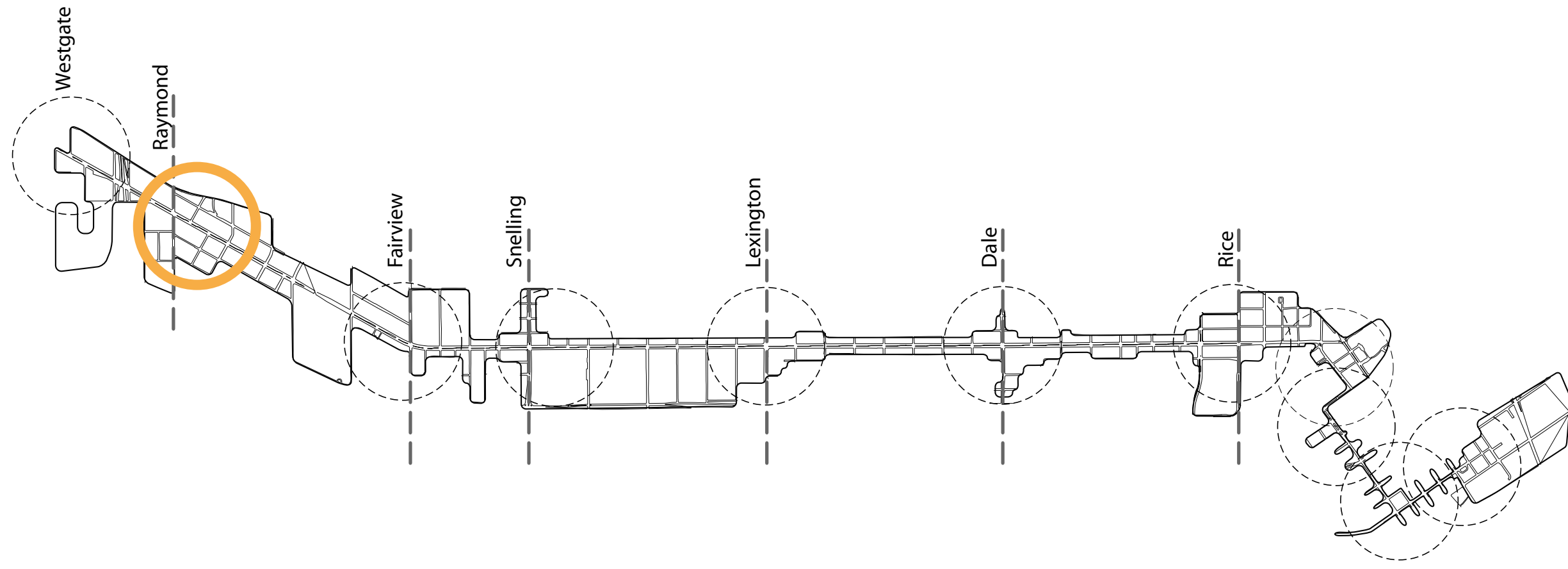

Table of Contents

1	The Raymond Station Area Today	- 05 -
2	The Future of the Raymond Station Area	- 11 -
3	Public Realm - Creating Places	- 17 -
4	Future Character Areas - Built Form & Land Use Policy Directions	- 23 -
5	Movement - Balancing Modes	- 37 -
6	Getting There	- 43 -

The Station Area Plans, Introduction, and Moving Forward chapters are adopted as addenda to the Central Corridor Development Strategy.

Planning for the Central Corridor

As stated in the Central Corridor Development Strategy (CCDS), Light Rail Transit (LRT) along the Central Corridor represents a tremendous opportunity for Saint Paul to become “a place that has stronger businesses, more vibrant neighborhoods, and more beautiful urban places.” The CCDS establishes a set of strategies for how the Corridor should grow and change over the next 25-30 years in response to the LRT investment. The station area plans, using the foundation of the CCDS, provide a more detailed framework for integrating decisions about future land use and development; the public realm; and the movement of LRT, buses, cars, pedestrians, and bicycles at each station area.

Planning for the Central Corridor is an opportunity to focus and guide future investment, both public and private, to create a stronger, more vibrant community that is a better place to live, work and do business. The goal is to support economic development and overall corridor prosperity that result in new housing at all income levels, more and better jobs and more business activity. The resulting increases in the property tax base and sales tax revenue will provide the resources for additional public services and infrastructure that, in turn, support economic development activity. The plans focus on an improved movement network, high-quality design, and improved open space and pedestrian amenities that will support and encourage economic investment, as well as create a more livable, attractive and vibrant community.

Station Area Plans and Future Development

The station area plans were developed through a series of community-based roundtables, workshops and open houses, guided by a steering committee of community representatives. Property owners, residents, business owners, and institutional and organizational representatives participated in this grass-roots process.

3-D Model of the Corridor. During the workshops, participants created a 3-D model of potential future development at station areas. The model depicts potential new buildings, open spaces and other public realm improvements. Since there is little vacant land along the Corridor, most of the change depicted involves redevelopment and replacement of existing buildings and surface parking lots. While photos of the model are used throughout these plans to illustrate how the principles and objectives for new development could be realized, it is important to note that the model represents only one of many possible development scenarios. The model is not intended to prescribe how new development will look, but to present one example of how the vision, goals and objectives of these plans might be realized. The intent was to model potential building height maximums, open spaces and streets to demonstrate transit-supportive developments for individual parcels.

Change Over Time. Change will occur when individual property owners decide it is either the right time to reinvest in their properties, sell to someone else who will reinvest in the property, or the City has the resources and appropriate public purpose to purchase property. Change will happen incrementally over time, and likely more slowly until LRT is up and running.



The Raymond Station Area Today

This chapter provides a snapshot of the Raymond Station Area's history, and a brief description of the physical conditions that are shaping the role and character of the Raymond Station Area today.

1

The History of the Raymond Station Area

The Raymond Avenue Station encompasses a large portion of the University-Raymond Commercial Historic District.

The station area is significant as the commercial core of the St. Paul Midway, which developed in the early twentieth century as the city's largest industrial area and a national transportation center. The foundation of the Midway District was laid in the late 1870s as the city's early railroad companies expanded service between Minneapolis and St. Paul. After World War I, much of the Midway District's development reflected the growth of truck transportation. Industrial functions were drawn to high accessibility of the Midway; In the 1920s, over half of the city's manufacturing plants were located in the Midway.

Nearly all of the properties in the district are related to some aspect of the activities of the railroad lines between the Twin Cities or the early years of the trucking industry. Most of the buildings were constructed between 1891 and 1941, during the decades when the Midway became St. Paul's largest industrial district. The properties are typically one to seven-story brick and stone structures that originally housed factories, warehouses, offices, and commercial spaces.



FIGURE 1.1 - Northwestern Furniture and Stove Exposition Building, built 1906.



FIGURE 1.2 - Chittenden Eastman, built 1917.



FIGURE 1.3 - Detail of the Specialty Manufacturing Company, built 1906.



FIGURE 1.4 - Twin City Wholesale Grocery Company, built 1931.

Source of photos: Minnesota Historical Society

The Raymond Station Area Today

The Raymond Station Area is distinguished by an enviable historic building stock, clusters of cafés, and small retail stores. This unique character must be strengthened and preserved through future development.

The University-Raymond Commercial Historic District, which encompasses all properties fronting University Avenue from Cromwell Avenue to east of Hampden Avenue, identifies and preserves the most unique and important elements that contribute to this place. The regulating status of this District empowers the Saint Paul Heritage Preservation Commission to review all new construction and renovation permit applications for conformance with the District's Design Review Guidelines, which set standards for ensuring consistency of development massing, height, lighting, parking and other elements.

In addition to its significant historic attributes, the proximity and access of the Raymond Station Area to transportation infrastructure – the confluence of two expressways and a spur line and rail yard – has preserved the strength of employment functions north, south, and east of the station. New investment in the retrofitted Carleton Lofts has reinforced the University Avenue streetwall and enhanced the strong creative and arts presence in the community. This historic manufacturing and warehouse district has evolved with a greater mix of live-work, studio and apartment uses, and neighborhood retail and services that support these districts. The result is an intermingling of residential and employment uses – a condition that will require careful consideration for all future infill and intensification.

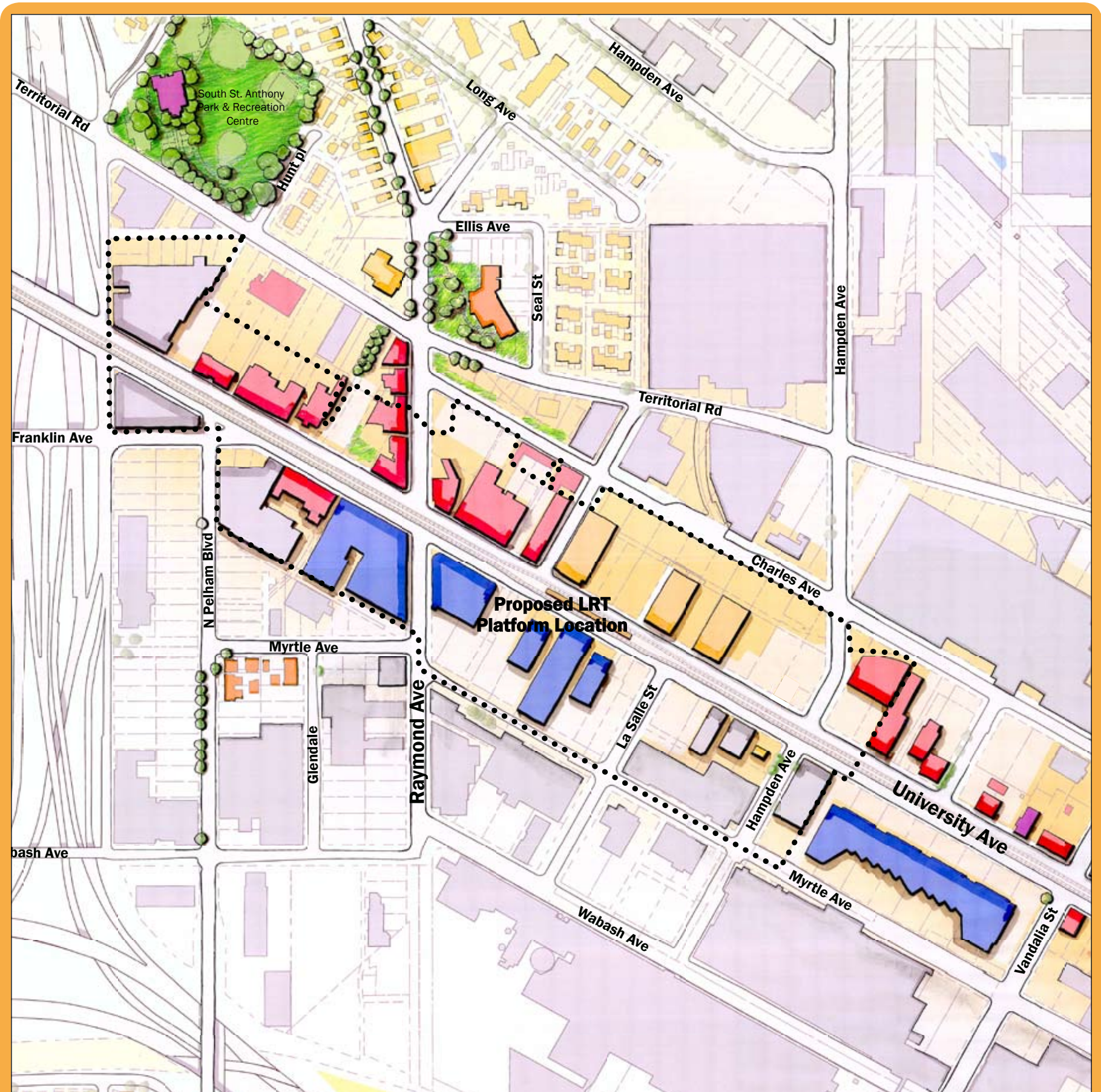

FIGURE 1.5 - The Raymond Station Area today acts as a major employment center. While office uses line the Avenue, there are also a significant number of large industrial buildings.

• • • University-Raymond Commercial Historic District



FIGURE 1.6 - A revitalized warehouse district is emerging along the **Avenue**.



FIGURE 1.7 - The **Carleton Lofts** is just one sign of how the Raymond Station Area is emerging into a new mixed use village comprised of traditional employment uses, newer residential and office development.



FIGURE 1.8 - The heart of **Raymond Village** is characterized by low-scale retail uses with continuous street frontage.



FIGURE 1.9 - The existing **Employment Areas** are an important source of jobs for both the Station Area and the city.



FIGURE 1.10 - **Charles Street**, with newer residential to the south and historic employment uses to the north, typifies some of the tensions the changing character of the Station Area is creating.



FIGURE 1.11 - **The Specialty Building**: Just one example of the fine historic stock that helps to define the Station Area.



The Future of the Raymond Station Area

2

The Future of the Raymond Station Area chapter describes:

- **the planned location of the future LRT platform;**
- **forecasted market opportunities for new growth and investment;**
- **a description of the Station Area Boundary and Areas of Stability and Change within the Raymond Station Area; and**
- **a vision statement describing the future potential role and character of the Station Area with regard to both the immediate community and the broader Central Corridor.**

The Future of the Raymond Station Area

The Raymond Station Area is a locally-designated historic district with a strong employment and residential character.

Even in advance of investment in the LRT, the sum of the area's recent reinvestment in historic buildings, strong neighborhoods, and healthy employment uses speaks to the potential to continually improve this Station Area as a complete and healthy community with vibrant public spaces, a range of movement options, a diverse mix of uses, and attractive buildings framing lively, pedestrian-friendly streets.

2.1 The Raymond Platform

The Raymond LRT stop is currently planned as a center split platform configuration (Figure 2.1) located on the east side of Carleton Street in the middle of University Avenue. Though the platform will be located on the eastern side of the intersection, access will be facilitated by signalized crossings on both sides of the University and Carleton intersection. As the intersection will restrict vehicles to right-turning and through movements, and prohibit left-turning movements, this dual-crossing configuration affords the unique opportunity to create a mid-Avenue pedestrian island that connects both signalized crossings directly to the platform. This refuge space should be designed to safely separate pedestrians from LRT tracks, and incorporate landscaping and/or public art features.

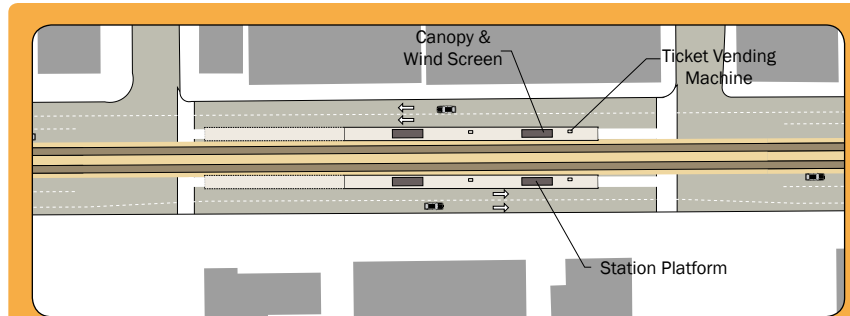

FIGURE 2.1 - Illustrative Raymond Center Platform Configuration

2.2 Market Forecasts

Building on the Central Corridor Development Strategy market forecasts, a detailed review of the Raymond Station Area characteristics and market potential was undertaken in order to consider the extent and timing of future development. These characteristics describe a market area with promising potential for both future office space and new residential construction, and moderate growth potential for retail. This strong office space market, which at 950,000 square feet is the largest

forecasted demand for any one Station Area, is fuelled by a number of factors including the area's centrality within the Region, its excellent access to transportation infrastructure, the presence of an already established employment cluster, and the architectural character and flexibility afforded by the area's historic buildings.

The combined identity related to history, arts and culture so prevalent here will also continue to attract new residents seeking an authentic and unique urban neighborhood, and will spur investment in the renovation of old and construction of new condominium lofts and apartment buildings. The continued preservation of the architectural character of this district, the provision of greater neighborhood retail and services, and the ability to successfully buffer employment, commercial and residential uses from one another, will be critical to realizing the tremendous potential this Station Area possesses.

The table below (Figure 2.2) provides the estimated breakdown of total potential development within the Raymond Station Area over the next 25 years.

Raymond Station Area Market Potential						
	Market Forecast 2030 (January 2008)	Pre-Construction 2008-2009	During Construction 2010-2014	Early Operation 2015-2020	Mature Operation 2020-2030	Specific Market Opportunities
Residential: Rent	450-600	170	130-280	150		Carleton Lofts launch Phase II. Later phase likely to be market rate. Likely to start Fall 2008.
Residential: Own	250-500	0	0	100-200	150 - 300	Condominium demand strengthens later years
Office Space (sq ft)	950,000	0	100,000	300,000	550,000	Midway point between cities; Hwy 280/94 access
Retail Space (sq ft)	60,000	0	5,000	15,000	40,000	Existing established main street retail businesses; US bank potential for mixed-use; 1st level retail.
Industrial (sq ft)	Preserve/Redevelop	-	-	-	-	-
Hotel Rooms	-	-	-	-	-	-

FIGURE 2.2 - The Raymond Station Area development forecast predicts excellent growth potential for new office space, though only modest investment in mixed-use infill development and related community facilities and services.

2.3 Defining the Study Area

The Raymond Station Area has potential to evolve as a place with more employment, a greater range of businesses, more vibrant neighborhoods, and new and enhanced beautiful public spaces. The station area plan process used four mapping layers to investigate and understand the Raymond Station Area.

The station area boundary extends east of the ¼ mile zone to capture larger potential development parcels located along Vandalia, and farther west and south to include a number of underutilized, sites with excellent access and frontage relative to Highway 280 and Interstate 94. This boundary is the primary focus for all recommendations contained within this document.

Within the boundary, a refined Area of Change has been delineated through the station area planning process. The Area of Change denotes the parcels where change is welcome and should be encouraged, whether through gradual infill, intensification or comprehensive redevelopment.

The current and future area of high pedestrian activity has been identified as a Mobility Enhancement Area. Section 5.0 of this Plan presents recommendations for balancing modes of movement within this active hub.

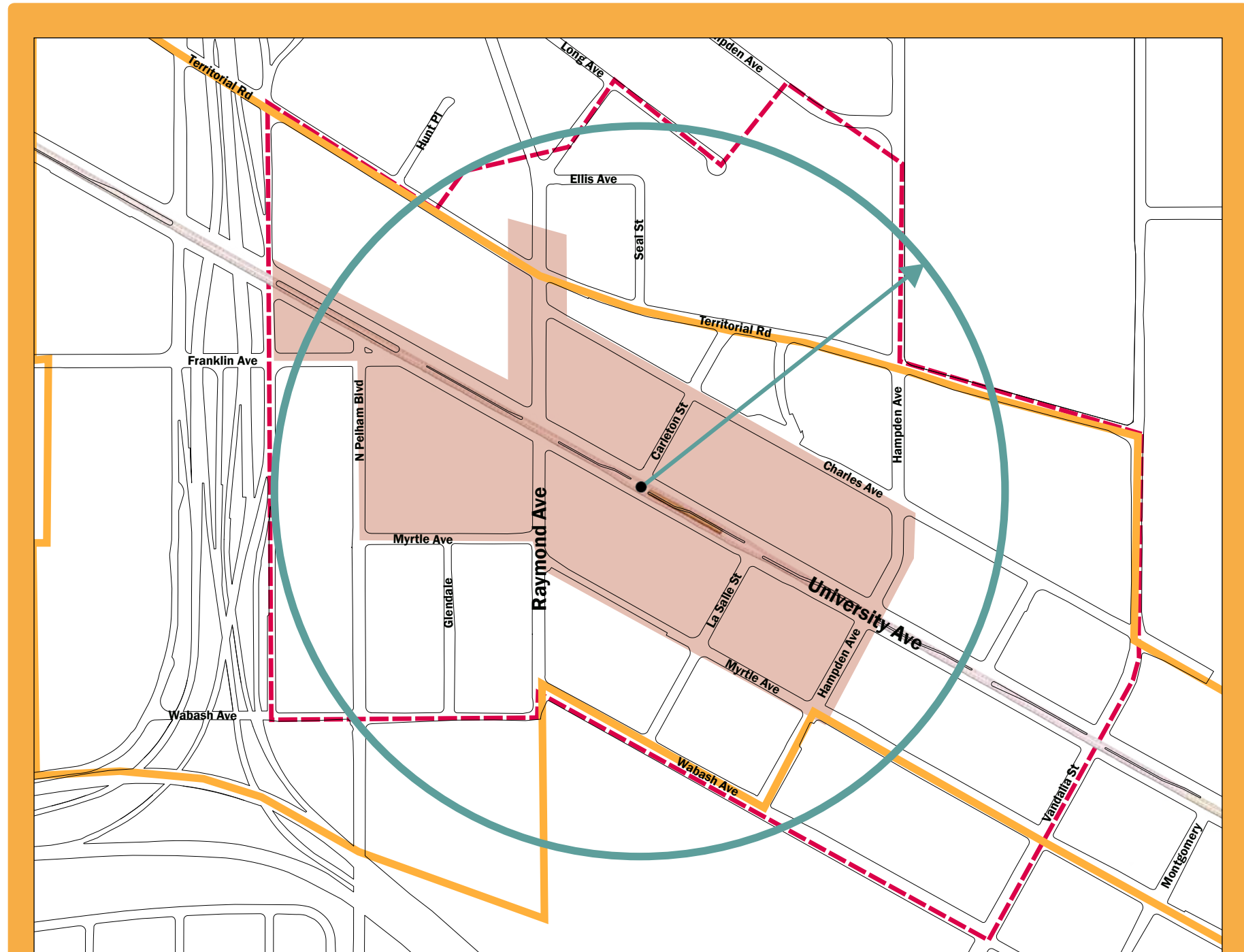

FIGURE 2.3 - The Four Lenses of Exploration illustrate the evolution in understanding the Raymond Station Area.

- Mobility Enhancement Zone
- Area of Change
- 5-minute Walking Radius (1/4 mile)
- Station Area Planning Boundary

The Future of the Raymond Station Area

2.4 Looking Ahead – the Raymond Station Area in 2030

Looking Ahead describes a community-crafted vision for the future of the Raymond Station Area. This narrative generally describes the sum of desired characteristics for this community, and its future role within the broader Central Corridor.

The Raymond Station Area will successfully accommodate new forms of residential and commercial infill, while preserving and strengthening both the historic character of the area and the integrity of its employment uses. The potential for a new employment district is identified adjacent to the confluence of Highway 280 and Interstate 94, where excellent access and visibility create a strong economic development opportunity. New development within the Station Area will reflect the architectural scale and character of existing historic buildings, to strengthen this emerging urban village.

Pedestrian routes to the Avenue will be improved to create legibility and connectivity with adjacent neighborhoods and employment uses. These routes will incorporate new pedestrian amenities and will be focused on Charles Avenue and Carleton Street to transform these spaces from their current industrial service function to vibrant urban streets.

The location of the LRT platform and its associated activity will extend the linear commercial core of this area eastwards from Raymond Avenue to Hampden Avenue, and strengthen University Avenue as a commercial main street. Further, a sequence of new green spaces will provide community gathering places and focal points along the Carleton Street spine to the future LRT Station platform.

Raymond Station Area Vision:

A model mixed-use urban village that successfully combines new and old: buildings, streets, land uses, and modes of transportation. This Station Area will evolve with an authenticity and sense of place that distinguishes it within the Corridor, and becomes a must-see district for visitors seeking to discover the places that make Saint Paul unique.

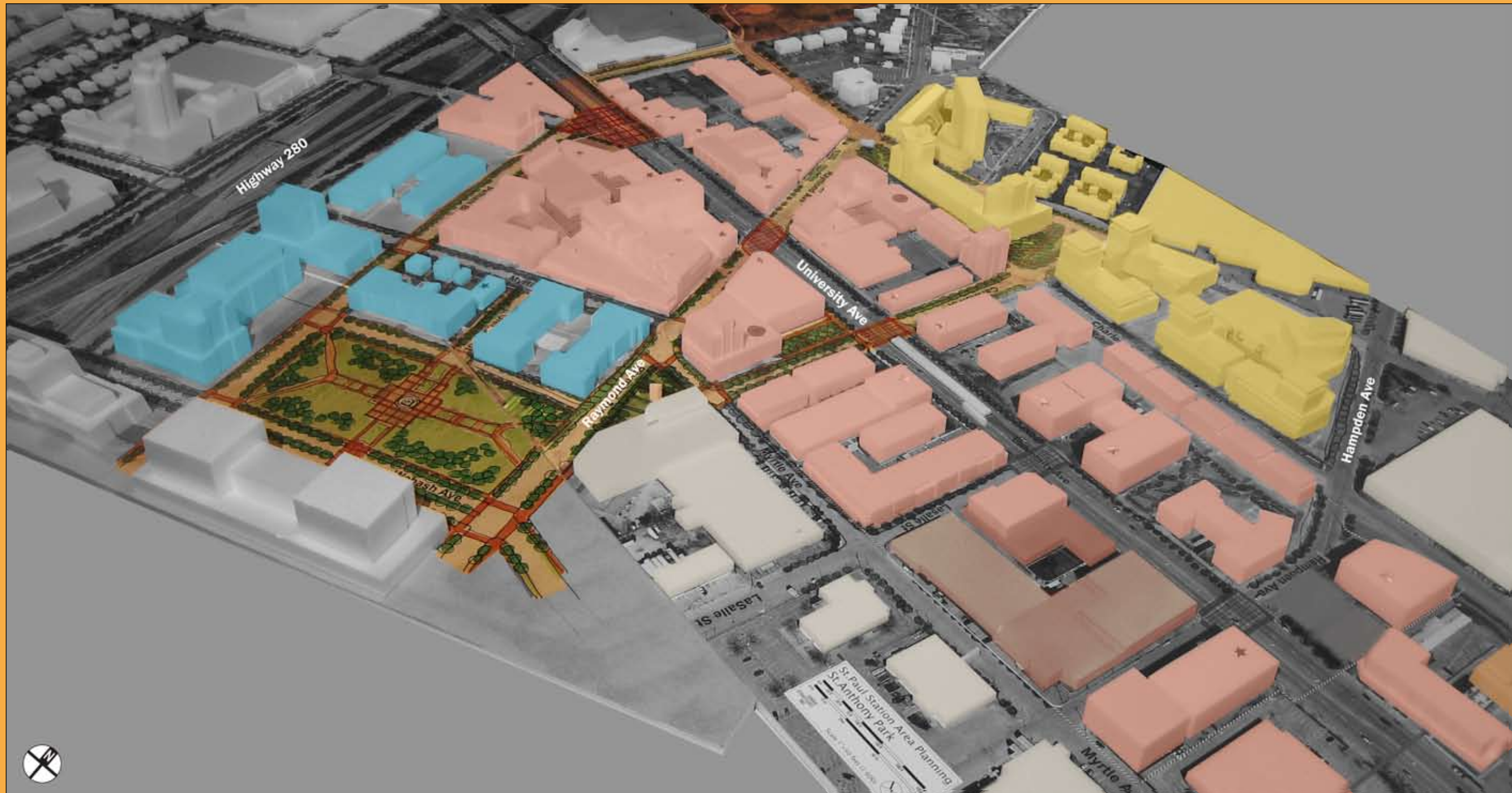

FIGURE 2.4 - The Raymond Station Area 2030: The physical model represented here illustrates one possible long-term scenario for meeting community and place making and transit-supportive opportunities. Rather than attempting to predict the location and distribution of anticipated long-term investment, this conceptual model illustrates the application of transit-supportive principles throughout the entire Station Area. The total development yield illustrated is therefore not meant to be precisely representative of the 2030 market forecast (Figure 2.2) for this Station Area, but demonstrates examples of transit-supportive developments for individual parcels.



Public Realm - Creating Places

The following *Key Moves* identify priority investments for improving the public spaces and pedestrian environment in the Raymond Station Area in a manner consistent with the Vision of the Central Corridor Development Strategy: a beautiful urban place with pedestrian-friendly, attractive tree-lined boulevards. These recommendations explore opportunities for streetscaping, new passive and active park spaces, community gathering places and expressions of public art.

A significant new network of public spaces is proposed to provide a set of integrated focal points for the future mixed residential and employment community, and to form an important hub within a larger pedestrian, bicycle and transit network.

The Raymond Station Area is lacking community gathering places that support the strong retail, employment and emerging residential communities. Further, pedestrian routes and connections, north and south of University Avenue to the adjacent South St. Anthony neighborhood and area employment uses, are inhospitable and, in some instances, non-existent. This condition is exacerbated by the strong industrial presence north of University and Raymond, which results in limited pedestrian amenity. Finally, there are opportunities provided by the shifting street grid to create distinct places along the Avenue.

Despite the strong role and contribution of the arts in this community, there are few expressions of public art to express community identity or commemorate the significant industrial history of the area.



FIGURE 3.1 - The Public Realm Plan illustrates a series of recommended *Key Moves* for creating an improved network of open spaces and pedestrian routes.

Ⓐ Public Art Opportunities

3.1 Raymond's Public Realm: Key Moves

The following *Key Moves* describe a series of ideas for future investment in the public realm. While the eventual location and configuration of these spaces may be different than the images presented here, developers, city departments and other stakeholders should strive to achieve the general intent and purpose of the *Key Moves* described below. These conceptual Moves will require a range of implementation measures - from allocation of municipal capital improvements budgets to private investment and parkland dedication and/or acquisition - determined on a site-by-site basis as development occurs.

A minimum of 14-foot sidewalks be established within the "Mobility Enhancement Area" defined for each station area. The Mobility Enhancement Area is the area around each station where a higher level of pedestrian activity is anticipated and a high-quality pedestrian environment is key.

Raymond Network of Public Spaces

A constellation of new public spaces and key pedestrian linkages will enhance livability and sense of place in the Station Area.

Charles Street Community Park

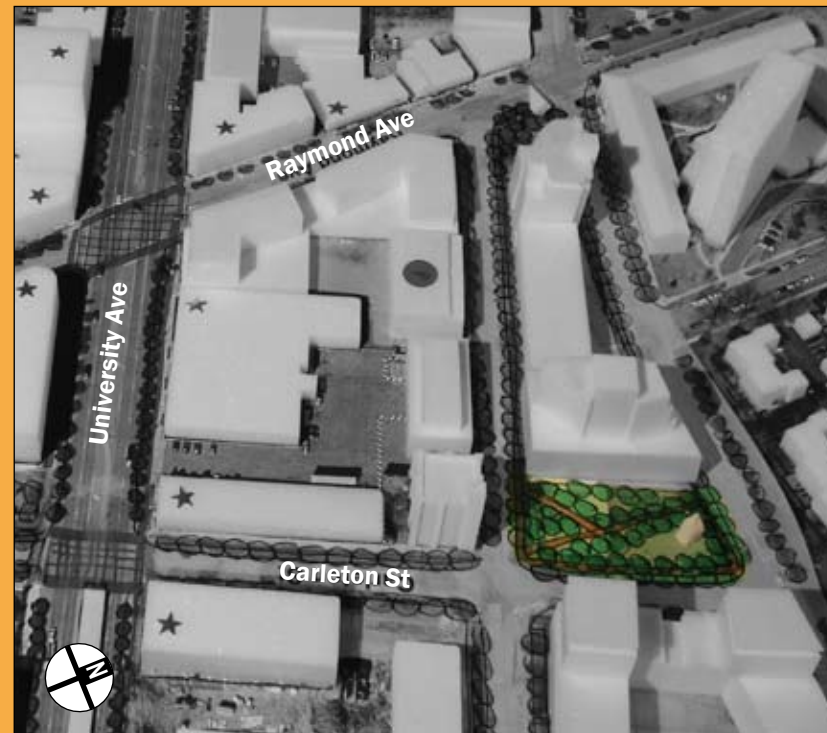

FIGURE 3.2 - The **Charles Street Community Park** introduces new public space for expanding residential communities.

A new neighborhood parkette is proposed at the corner of Charles and Carleton as a focal point for new residential development north of the Avenue. The passive park space would provide frontage for taller residential buildings to the west and be the first of a series of public spaces along the Carleton spine, linking south to the LRT station.

Wabash Commons



FIGURE 3.3 - **Wabash Commons** is a focal point for the larger bicycle and pedestrian movement network and the new redevelopment parcels surrounding it.

A significant public space is proposed along the north side of Wabash to create a focal point for a future employment hub south of the Avenue. Similar to its proposed sister 'Commons' in the Westgate Station Area, the Wabash Commons is intended to be a high-quality space, enhancing the place making and real estate value for adjacent office and employment uses. Its size will support both active and passive uses.

The Myrtle Hinge



FIGURE 3.4 - The Myrtle Hinge creates a link between Carleton Street and Wabash Commons.

At the confluence of Wabash, Raymond and Carleton - each a key movement route - there is an opportunity for a placemaking space that marks this intersection. Achieved within the pedestrian boulevard or through future building setback, the proposed Hinge Park creates a gateway moment, potentially celebrated through public art, to the Raymond Station Area.

Top of the Village Park



FIGURE 3.5 - Top of the Village Park will mark an important gateway to the area at the intersection of Raymond, Charles and Territorial.

Currently a surface parking lot exists on this remnant site. Landscaping and tree planting can help to green this space as a notable passive park gateway at the top of the Raymond urban village. This and the other spaces of the Raymond network will over time contribute to the finer-grained, village character of the Station Area, and should be designed to serve expressly local needs for area residents and employees.

Opportunities for Public Art Expression



FIGURE 3.6 - This bench on Raymond Avenue illustrates how **public art** can be fully integrated within the public realm and help to improve what is otherwise a bleak condition.

Public art should become an integral part of all future development and public realm projects within the Station Area. The public art collection should express distinct station area character as well as the wholeness and continuity of the corridor.

Public art is:

- 1) the result of including artists on professional design teams to affect space design from the initial stages of planning;
- 2) the creation of site-specific objects to beautify public spaces, improve their function and enhance their meaning in the community; and
- 3) the creation of site-specific experiences using various art forms and media, including time-based works, to enhance the sense of place.

Public art strategies should engage both public agencies and private property owners and developers as they build the city.

While public art opportunities are broadly available to national and even international artists, special efforts should be made to engage local artists.

In this burgeoning arts district, there are opportunities for private property owners to engage artists as they envision their overall developments and holdings and to commission public art, particularly where private property intersects the public right-of-way.

In this neighborhood of parks, artists should be engaged by Saint Paul Departments of Public Works and Parks to participate in streetscape and open space design.

Artists engaged in shaping the form and experience of the key station areas should consider the following concepts and opportunities identified through the workshop process:

- **Wabash Commons, Myrtle Hinge, Top of the Village Park and Charles Street** park network offer opportunities to explore and illuminate the history and promise of the Raymond Area through interactive installations and interpretive walkways.
- **Pelham University Gateway:** a left over space, offers opportunity to mark and celebrate the entrance to the Raymond Station Area.
- **Carleton LRT Crossing,** an “orphaned” space, may be leveraged to create a platform crossing integrated into a landscape that explores the history and character of the area and that expresses themes identified by artists working with the community.
- **The Raymond LRT Platform** offers the opportunity to define and distinguish the station and its surrounding community, to tell the story of the area’s rich and evolving cultural history, and to express the significance of LRT as a public asset for the residents, students, workers and visitors it serves.



Future Character Areas - Policy Directions

Recognizing the diverse places within each station area, a series of distinct *Character Areas* have been identified for the Raymond Station Area.

Utilizing a series of working 3D foam models produced in community workshops, this section builds on the transit-supportive development types identified in the Central Corridor Development Strategy to describe historic and emerging *Character Areas* within the Raymond Station Area. Each *Character Area* contains a series of policy directions to guide future investment and change in built form, land use and circulation over time. These directions include identifying the appropriate location and scale of taller buildings; strategies for transitioning to stable neighborhoods; a desirable mix of transit-supportive uses; and recommendations for accommodating a system of movement that balances modes of active, transit and automobile transportation.

This section is illustrative of how the goals and objectives of the station area plan may be realized. It is intended, in the case of transit-supportive development or other development that will increase density within station areas, that the policy directions under this section be interpreted to support flexibility in the application of these guidelines in order to achieve transit-supportive or denser development within station areas.

4.0

Westgate | **RAYMOND** | Fairview | Snelling | Lexington | Dale | Rice

Future investment in Raymond’s Station Area must build on and strengthen the qualities of the University-Raymond Commercial Historic District.

Preserving the integrity and character of the area’s defining architectural history will be vital to the continued success of land use and development in the Raymond Station Area. Nothing in this plan should be deemed to contradict the University-Raymond Commercial Historic District Design Review Guidelines, but should instead reinforce, and be read in conjunction with, this important legislative document. Also, important to the long term economic and social health of the area is the preservation of viable employment uses with a long term economic future, while continuing to promote new and diverse residential and employment uses that are transit-supportive.

The Raymond Station Area requires a flexible and permissive land use strategy that emphasizes connectivity, design performance and transit-supportive qualities, including a broad mix of uses, flexibility of regulation over time, active first level uses, and shared parking solutions. Together, these approaches will assist to strengthen and repair the area’s “Main Street” quality, and reinforce the fabric of the area as a complete community with housing, employment and movement options for all.

While this overall direction will help guide change over the entire Raymond Station Area, this section describes four distinct *Character Areas* that will require specific policy direction to achieve their built form and land use potential over time. The following *Character Areas* descriptions and policy directions provide clear guidance to the forms of development and investment that will support the future of the broader station area.

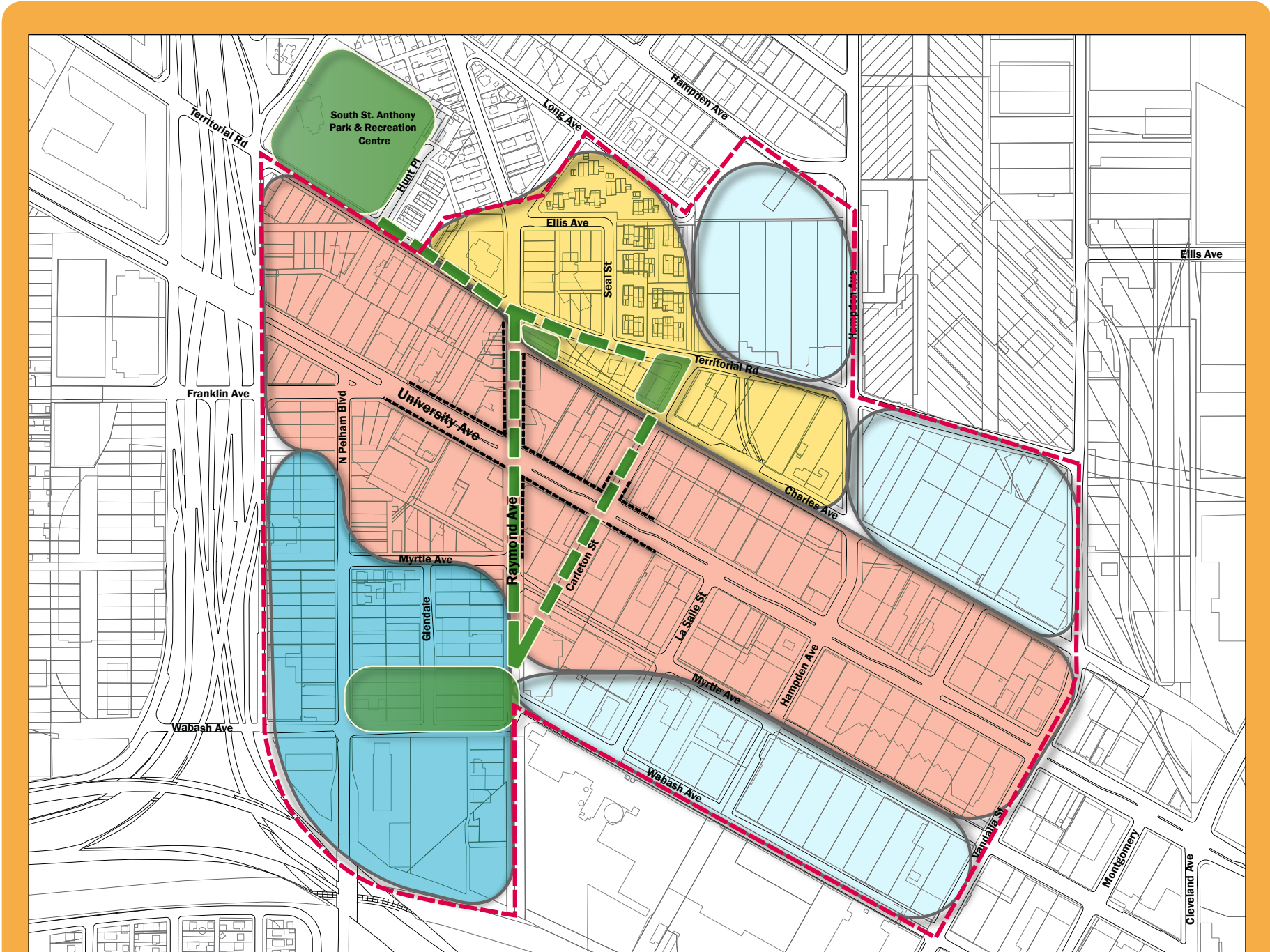

FIGURE 4.1 - The Raymond Station Area is comprised of four distinct yet overlapping *Character Areas* each with their own unique potential over time.

- Raymond Historic Village
- Extending the South Saint Anthony Neighborhood
- Park Space
- A Prestige Employment District
- Priority Active Frontage
- Key Open Space Connection
- Station Area Planning Boundary
- Supporting Stable Employment

4.1 Raymond Historic Village

The Raymond Historic Village will be a model of a vibrant commercial corridor that supports people living and working in a revitalized historic district.

The University-Raymond Commercial Historic District, designated by the Saint Paul City Council in 2005, developed in the early 20th century (1891-1941) as the city's largest industrial area and a national transportation center. Nearly all of the properties in the district are related to some aspect of the activities of the Minnesota Transfer Railway, or the early years of the trucking industry. The district's 22 contributing buildings, most of them with high exterior integrity, reflect the evolution of the area from the railroad era to the interstate highway system era. A set of design review guidelines was adopted by the City Council when the district was designated. They are used by the Saint Paul Heritage Preservation Commission (HPC) to review permits for rehabilitation, restoration, new construction and demolition. The guidelines address masonry and walls, windows and doors, signs and accessories, new construction, non-contributing and contemporary buildings, and demolition. Any proposed development within the historic district boundaries will need to comply with the HPC's guidelines, as well as the key moves and policy directions in the Raymond Station Area Plan.

The adaptive re-use of existing historic and employment buildings, and the sensitive construction of infill uses, will combine a range of residential, commercial, employment and cultural uses while maintaining and strengthening the scale and character of the existing village. Pedestrian-scaled streets will connect the main spine of the Avenue north and south to a wealth of employment anchors and stable residential communities. The LRT platform will effectively extend the village qualities of the Avenue east to Carleton. Though the Raymond village is primarily focused along University Avenue, larger full-block development parcels will exhibit a relationship and secondary orientation to inner blocks where employment uses are located.

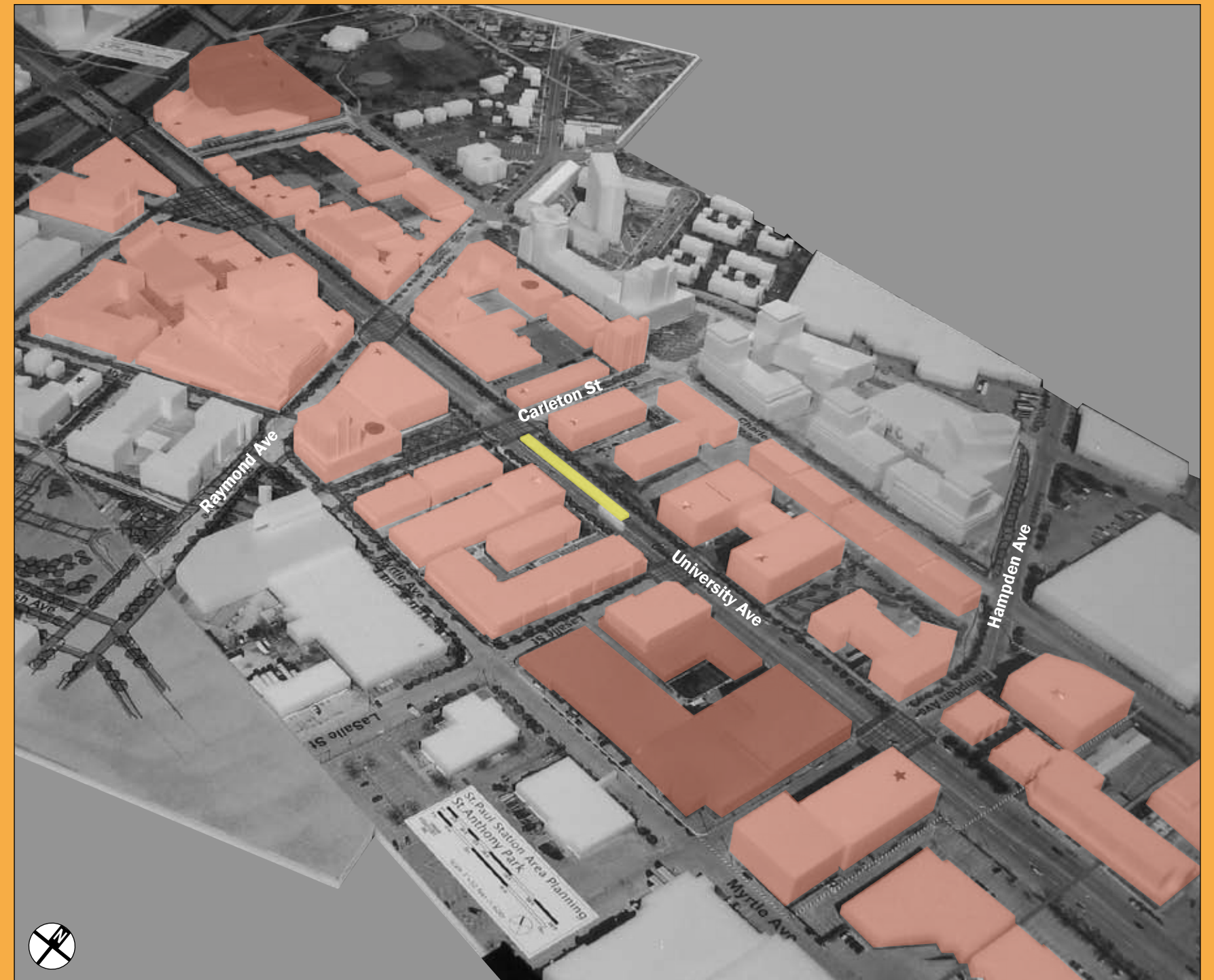

FIGURE 4.2 - The gradual infill and intensification of the Station Area over time will help to reinforce and extend the existing character of the Village as a mixed-use urban neighborhood. The model is intended to represent one possible built form scenario, and it is not intended to be interpreted as prescriptive for evaluating future development proposals.

4.1.1 Built Form

New development should fit with its surroundings.

- New development along University Avenue should be 2 to 6 residential stories in height with transitions that respect the existing scale and character of the historic buildings along the street. The northeast corner exhibits potential for taller building heights, and could reach 6-8 stories if setback from the intersection on a 3-4 story podium-type building.
- New development should ensure that buildings have strong street presence along University, Charles and Myrtle. Buildings along Myrtle and Charles may step down to two stories.
- New development should be sited to ensure an adequate public realm and pedestrian promenade.
- New buildings on corner sites should front both streets and utilize their corner positioning as a distinctive feature in their design similar to the Specialty Building.
- Building design should incorporate materials and an architectural style that is distinguishable as contemporary, yet compatible with adjacent historic buildings through scale, rhythm, color and materials, while meeting the University-Raymond Commercial Historic District Design Guidelines.

All new development should promote transparency and activity at street level.

- First floor commercial or retail uses should help to animate the street by incorporating large glass frontages that allow the activity within to be seen from the street and have at least one entrance that is oriented towards Raymond or University Avenue, access points to the station platforms, and/or key gathering places.
- Commercial or retail uses should be located in the first floor of all buildings within the Priority Active Frontage zones identified on page 25.

4.1.2 Land Use & Development Pattern

Urban Infill along the Avenue should have many uses.

- A broad mix of uses should be concentrated along the edges of the Avenue where they provide an easy connection to public transit, and benefit from the visibility and profile of being located on a major transportation corridor.
- Live-work units may be permitted on the first floor of all buildings beyond the Priority Active Frontage areas.

All new private development must contribute to adjacent streetscape improvements.

- Where there is not sufficient public right-of-way for new street tree planting or public realm amenities, new buildings should be setback from property lines to establish an outdoor area for seating, display space and/or landscaping as appropriate. A minimum pedestrian promenade dimension of 14-feet would provide for street trees, sidewalk, and some outdoor seating space.
- Developments within the area defined as Priority Active Frontage should provide for active uses at grade to support their immediate proximity to the future LRT station platform.
- Building gaps along the street frontage within the Station Transfer Zone should be discouraged. Where gaps do exist they should be adequately landscaped along the street frontage.

Enhance the connectivity and pedestrian supportive character of streets.

- Protect the extension potential of Carleton Street south of the Avenue to establish a pedestrian connection from the station platform to Myrtle Street.
- As development occurs, seek opportunities to increase north/south mid block connections such as the one created at Carleton Lofts.
- All streets should provide sidewalks, adequate lighting and streetscape amenity.

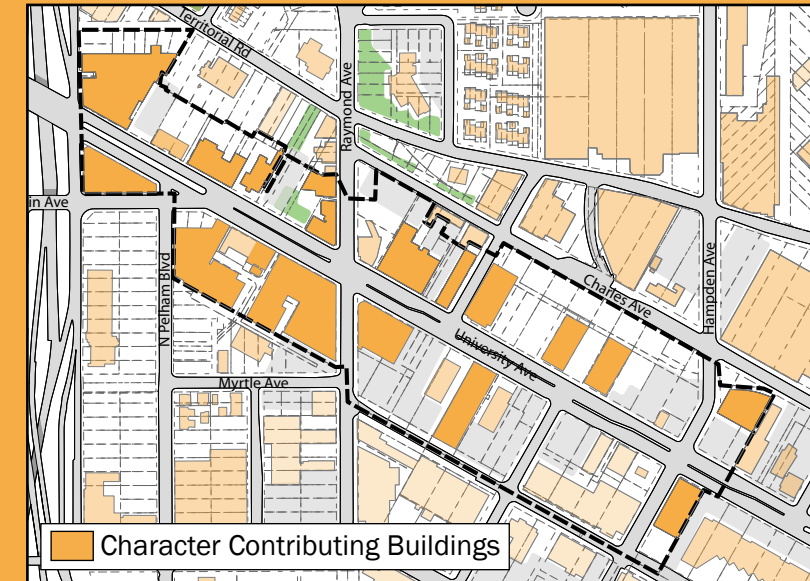

FIGURE 4.3 - The University-Raymond Commercial Historic District outlined above is comprised of numerous contributing buildings, many of which are 1-2 stories in height. New development should respect the scale and character of the existing buildings while filling in the gaps to intensify the district. Gradual infill and intensification around this historic mixed-use village in Toronto (bottom) helps to reinforce the existing character of the area.

4.2 A Prestige Employment District

The accessibility and centrality of Cromwell Avenue, relative to highway infrastructure and employment uses, provides a strategic economic development opportunity to create a stronger employment hub with a highly visible corporate address.

This highly visible and accessible frontage would be ideal for a linear corporate campus for large corporate office buildings or a series of multi-tenanted research park, laboratory and office buildings. These attributes may also make the area attractive for a new hotel and conference center catering to downtown Minneapolis and Saint Paul, the University of Minnesota, and/or the general Twin Cities Region market.

The reconfiguration of Cromwell Avenue from a discontinuous service road into a fully-functioning urban boulevard will be critical to the success of this bold scheme. Along Cromwell, a high level of investment in quality streetscaping and public realm should set the standard for future commercial development along the Station Area's western edge.

This strong employment-driven strategy would further create a natural synergy with new prestige employment uses on the opposite side of Highway 280, with both Wabash Avenue and Franklin Avenue providing improved east-west access between the two employment clusters.

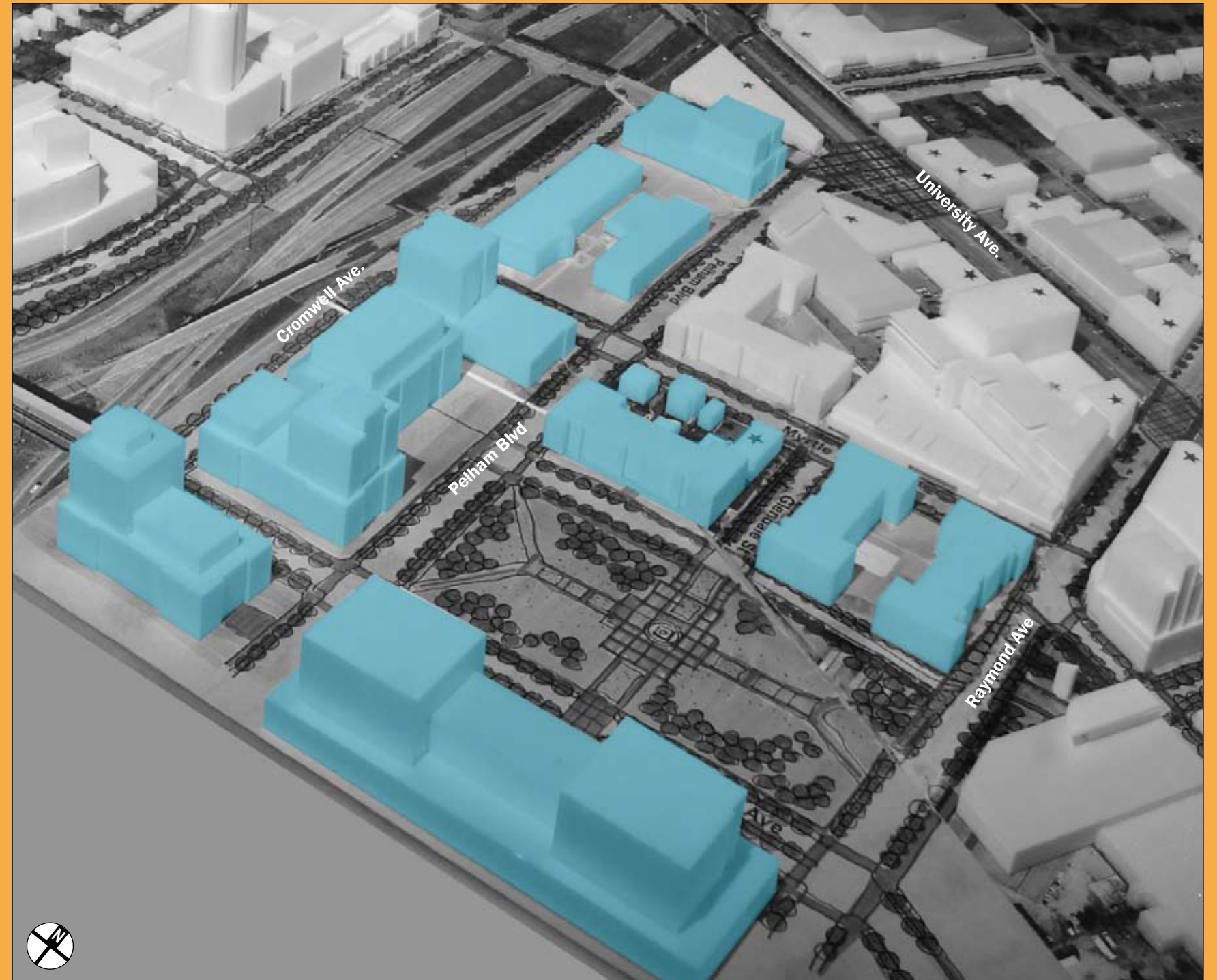

FIGURE 4.4 - A re-configured and redesigned Cromwell Avenue would help to create a prestige frontage along Hwy 280, while a new open space would provide amenity, link with the Raymond Village Open Space network and provide a framework for the development of new employment uses to the east.

4.2.1 Built Form

Create a prestige employment address.

- The architectural design of buildings along Cromwell will create landmarks that mark and distinguish the prestige of this area.
- To spur market and investment confidence, there should be no height limit for building parcels fronting directly onto Cromwell Avenue. This approach will also permit design flexibility in creating iconic, sky line buildings.
- Further east and toward the center of the Station Area, buildings should step down to a maximum height of 6-8 stories around the proposed Wabash Commons. Buildings on the north side of Wabash Commons should step down in height towards Myrtle to better transition to the heights of historic buildings between Myrtle and University.
- Full-block, large floorplate commercial developments should be permitted.
- New development should exhibit a strong relationship to both the Cromwell frontage and Wabash Commons to ensure there are no backlotting conditions on either of these important spaces. Commercial uses should be principally oriented towards Cromwell Avenue. Buildings adjacent to the Commons should have direct access to it.
- All development should contribute to a coordinated landscaping and streetscaping program for Cromwell Avenue.
- Where there is not sufficient public right-of-way for new street tree planting or public realm amenities, new buildings should be setback from property lines to establish an outdoor area for seating, display space and/or landscaping as appropriate.

4.2.2 Land Use & Development Program

Promote a prestige employment hub in Saint Paul.

- Land use should be geared primarily to employment, hospitality, convention, entertainment, and related ancillary services and uses in order to maximize this economic development opportunity. Limited residential uses should be restricted to the edges of Wabash Commons.
- Ancillary uses and services should be restricted to the first floors of all new development, and oriented towards Cromwell Avenue and Raymond Avenue.
- Large format retail should be prohibited within this Station Area. Retail should only be permitted as a secondary use within a mixed use development and should not exceed more than 20% total gross floor area of the building.

Develop parking solutions for large employment uses.

- This *Character Area* may provide an opportunity to construct a publicly or privately-owned and operated parking ramp for shared use by area destinations. This ramp may serve Station Area businesses on weekdays and special event parking during weekends and evenings. This approach will help to provide alternatives to driving downtown and to reduce hide and ride pressure in adjacent neighborhoods during special events.



FIGURE 4.5 - A large open space with integrated stormwater management helps to provide structure and create a prestige address for this employment district in London, UK.

4.3 Supporting Stable Employment

The stable employment uses located in the eastern quadrant of the Raymond Station Area are a vital part of this community and should be preserved and strengthened.

The above statement does not necessarily imply that no change should happen here, but that new investment should be compatible with existing employment uses while promoting a transit-supportive environment that concentrates jobs around transit, improves the public realm as well as edge conditions and relationships with adjacent uses.



FIGURE 4.6 - The existing employment uses are a vital part of the Station Area.

4.3.1 Built Form

Strengthen employment uses.

- a) Recognizing the nature of the employment functions located here and the lower-intensity building forms that traditionally support these uses, future redevelopment and intensification of employment uses should be exempt from meeting minimum development densities.
- b) Where redevelopment of employment uses occurs, principal entrances should be well defined and oriented towards the adjacent public street.

4.3.2 Land Use & Development Program

- a) Notwithstanding an exemption from minimum development densities (as described above), future redevelopment should be encouraged to incorporate employment uses with higher employee densities than are located here today.
- b) Land use should continue to be predominantly employment, though should not preclude ancillary retail and services that support core employment functions.
- c) Nuisance uses such as heavy industrial, manufacturing, and outdoor storage uses should be prohibited.
- d) Surface parking may be permitted in this area, though it should be buffered by landscaping when adjacent to public streets.



FIGURE 4.7 - The landscaping and sidewalk treatment put in place to coincide with the refurbishment of the Carlton Lofts helps to improve the relationship of the development with adjacent employment uses.

4.4 Extending the South Saint Anthony Park Neighborhood

The wedge-shaped blocks formed by Hampden Avenue, Territorial Road, Raymond Avenue and Charles Avenue, and bisected by Carleton Street, occupy an important, central location relative to the many uses within the Raymond Station Area.

As development pressure and land values increase over time, these blocks should evolve as a mid-rise residential extension of the South Saint Anthony Park neighborhood that improves the connectivity of this neighborhood to the Avenue. This area should further act as a transitional area that improves the relationship between the mixed-use corridor to the south, employment uses to the northeast, and the predominantly residential neighborhood of South Saint Anthony Park located to the northwest.



FIGURE 4.8 - New development north of Charles Avenue will help to improve the relationship between the established neighborhood of South St Anthony Park, emerging residential development and existing employment uses.

4.4.1 Built Form

Promote a medium density urban neighborhood.

- Building types should consist of mid- to high-rise residential buildings with height generally in the range 3-4 story mid rise podiums with heights of 8-10 stories permitted at corners in slender, 'point-tower' building configurations on 3-4 story bases.
- Where residential infill potential exists on the Seal high rise apartment site, redevelopment should consist of either 2-3 story townhouses or mid rise apartment buildings in the range of 3-4 stories, which will help to integrate with the scale of surrounding development.
- Building heights should transition down to the lower intensity residential uses located in the South Saint Anthony neighborhood to the northwest.

4.4.2 Land Use & Development Program

- Land use within this *Character Area* should be predominantly residential, with potential for live-work units and limited neighborhood retail and services located on the first floor. Where feasible, buildings should provide grade-related residential units with private entrances to enliven the surrounding streets and create long-term flexibility needed for creating live-work units.
- Private residential parking should be provided in parking structures. On-street resident and visitor parking should also be encouraged to meet parking demands of new low-density residential development.

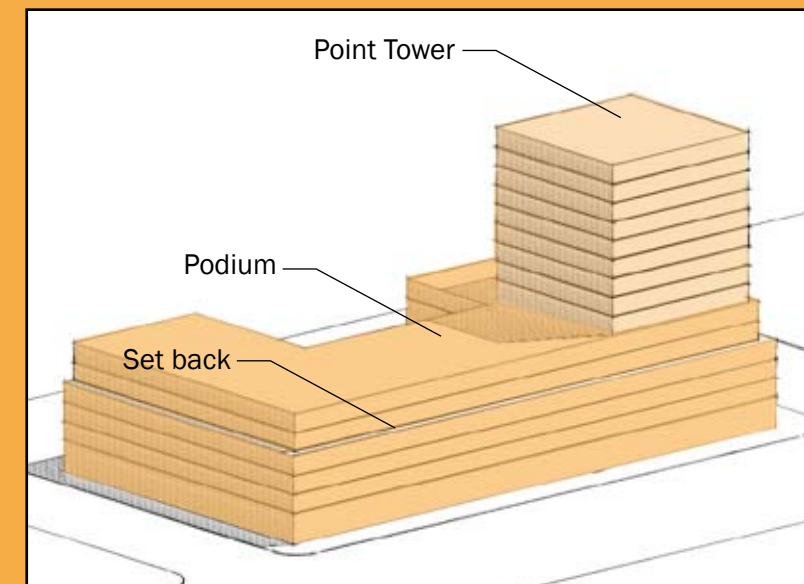

FIGURE 4.9 - The Carleton Lofts (top) provide a good example of mid-rise live/work development.

An example of a typical 'point tower' (bottom) illustrates how the tower is set back from the base podium to reduce the tower's impact at street level.

4.5 Managed Parking Strategies

Accommodating parking associated with existing businesses and residents and new development will be an important challenge as the Raymond Station Area evolves.

To properly assess and manage Park & Ride and Hide & Ride, comprehensive strategies must be implemented so that remaining on- and off-street parking can best serve residents and businesses in the corridor, and support walkable, transit-oriented neighborhoods.

Clearly, the reliance on surface parking at current development standards is a large contributor to the underutilization of land within the Station Area. A transformation from surface parking to structured and underground parking will need to happen over time and in conjunction with new development. The following policies provide the direction to facilitate this transformation that will be critical to the creation of active and vibrant streets within the Raymond Station Area.

- a) The establishment of new single-use surface parking lots on University Avenue, and the expansion of existing lots within the station areas, should be discouraged.
- b) Major redevelopment sites should be explored for opportunities to create shared, structured or below grade parking.
- c) Where surface parking occurs along University Avenue this should occur to the side or behind buildings and be limited to a maximum of 60-feet in width (for the provision of 2 parking aisles and one drive aisle) and should utilize landscape buffers to minimize the impact on the pedestrian environment.
- d) Parking requirements should be reduced or eliminated to reduce development costs, support transit ridership and open new possibilities for flexible live-work spaces on smaller sites where on-site parking is not available.
- e) On-street parking opportunities should be maximized to reduce the demand for private, off-street parking. This can be accomplished by minimizing curb cuts on all major streets by consolidating driveways, implementing flexible stall spacing, and utilizing meters and time-limited signage on side streets to ensure higher vehicle turnover.
- f) Access to surface parking lots from side streets or alleys should be encouraged. Curb cuts on University Avenue should be minimized and consolidated as opportunities arise, encouraging shared access with neighboring uses.
- g) The implementation and management of the current residential permit parking system should be evaluated.
- h) Both long- and short-term covered bicycle parking should be provided.



FIGURE 4.10 - A 56-foot wide surface parking lot in Portland, Oregon incorporates features such as permeable paving, integrated bike parking and pedestrian scaled lighting. It is heavily landscaped and concealed from the street by an integrated former building facade.



Movement - Balancing Modes

This chapter contains strategies for improving options to move to, from and within the Raymond Station Area. These include *Connections* to improve the linkages, safety, efficiency and quality of pedestrian and cyclist routes; and *The Mobility Enhancement Area*, to provide safe and efficient pedestrian access to the Raymond LRT platform and destinations along University Avenue.

Future improvements to movement within the Raymond Station Area should be focused on two key themes: improving bicycle and pedestrian crossings to the west; and improving pedestrian amenity or key connections between residential and employment destinations both north and south of the Avenue.

Key transit ridership generators for the area include the Seal high-rise apartment building, the multitude of uses and services located in the Midtown Commons building; the recently renovated Carleton Lofts, and the mix of neighborhood goods and services clustered within and around the historic buildings at the intersection of Raymond and University. The Raymond Station Area is also one of few opportunities along University Avenue to catch a direct bus connection to the Saint Paul campus of the University of Minnesota.

Recommendations for improving and expanding mobility options are structured here into two key themes:

The first theme is *Connections*, which describes a strengthened pattern of mobility options for pedestrians, transit riders and cyclists in reaching destinations within the Raymond Station Area from throughout the Central Corridor's many neighborhoods and the broader region;

The second theme is *The Mobility Enhancement Area*, which more closely examines the future impact of the LRT on movement patterns in and around the proposed platform location, and provides recommendations for ensuring a safe, efficient and amenable pedestrian experience for area residents, workers and visitors alike.

5.1 Connections

The goal of this section is to identify improved movement options for pedestrians, transit riders and cyclists in reaching the Raymond Station Area from adjacent neighborhoods and the broader Corridor. The *Connections* diagram (Figure 5.1) identifies key routes to and within the Raymond Station Area, and illustrates recommendations for improving the connectivity, safety, efficiency and quality of these routes for pedestrians and cyclists, including:

- Carleton 'island' should provide opportunity/option for platform crossing; west side of La Salle is a preferred option for secondary crossing.
- Consider the need for services in the area for visually impaired – may require an option for a second signalized and audible crossing.
- Vandalia extension to the University of Minnesota and the fairgrounds to provide a new north-south connection; also, Vandalia should extend down to the greenway.

Extending Carleton Street as a Key Spine

- In conjunction with long-term redevelopment of adjacent properties, Carleton should be extended as a pedestrian street south of the Avenue to intersect with Raymond Avenue. This extension should be an exclusive pedestrian route or pedestrian-prioritized road to connect destinations south of University directly to the LRT platform.
- Carleton needs to balance increased demand for bikes and pedestrian options with narrow lanes, marked bike lanes, traffic calming and sidewalks, and marked crossings at Territorial.

Bicycle Routes Need to Reinforce Centrality of Raymond Through Better Connections

Route options for cyclists reaching the Raymond Station Area, and in particular the future Raymond LRT platform, are circuitous and inefficient. Improving this condition will require extending bike lanes along Franklin east from Minneapolis to connect with Pelham Boulevard, a major north-south connection to the Mississippi River, the Midtown Greenway, Desnoyer Park, and other destinations.

The Wabash crossing of Interstate 94 should also be improved with better provisions for cyclists. This route, upon reaching Pelham Boulevard, should connect with an extended Carleton Street in order to provide a direct connection to the future LRT platform.

Midtown Greenway Connection

The long-term feasibility of reconciling grade difference between Pelham Boulevard and the future Midtown Greenway bike route should be explored.

Need future extension of Territorial to Minnehaha

The rail yard and cluster of large, industrial uses located to the north-east of the Raymond Station Area sever needed east-west connections with the rest of the Corridor. The ability to connect Territorial over the heavy rail corridor, either through a grade-separated or at-grade crossing, and east to Minnehaha would provide a critical missing link in the larger regional bicycle network. The long term feasibility of this large undertaking should be explored, with options for land conveyance from future redevelopment explored.

Future Bus Service

The Route 16 serves a distinct market apart from the proposed LRT service. When the Route 50 was added it did not diminish the ridership on the Route 16, as the Route 16 is particularly important to those who cannot easily walk long distances – the very young, the very old, those who are transporting goods (i.e. groceries and some durable goods) and/or children, and those who are transit-dependent with physical limitations. Although not uniformly true, most of these patrons need service more during the midday, and on weekends; rather than during the peak hours. Therefore, it is important that the current Route 16 service during the mid-day, evenings and weekends be retained.

The Route 94 service, running between the downtowns will also be retained, but with an abbreviated schedule. The abbreviation of the service should continue to meet the demand for express service between downtown Minneapolis and downtown Saint Paul.

As for the specific north-south service, it is essential for north-south service to be bolstered. The area includes relatively high residential densities, high transit-dependent populations and numerous jobs. As such, a ½ mile urban grid of transit service is considered desirable. To accommodate timed transfers between the 1 mile grid of north-south bus service and LRT, bus service should be no less frequent than meeting the LRT every other train (15 minute frequency) during peak hours. In particular for the Raymond Station Area 15 minute peak-hour and 30 minute non-peak hour minimums on route 67 connecting Highland Park, Cleveland Avenue, Saint Anthony Park, the St. Paul Campus, and the Rosedale Transit Center are required.

Improved Freeway Crossings

As freeway crossings (with traffic bridges) are redesigned and reconstructed, include widened sidewalks, crash barriers between traffic & sidewalk, pedestrian-level lighting, and approach sidewalk lighting & landscaping. Pedestrian-only freeway crossings should be rebuilt or retrofitted to include well-lit crossings of St. Anthony and Concordia, bridge lighting, and careful landscaping that does not obscure views to and from the bridge.

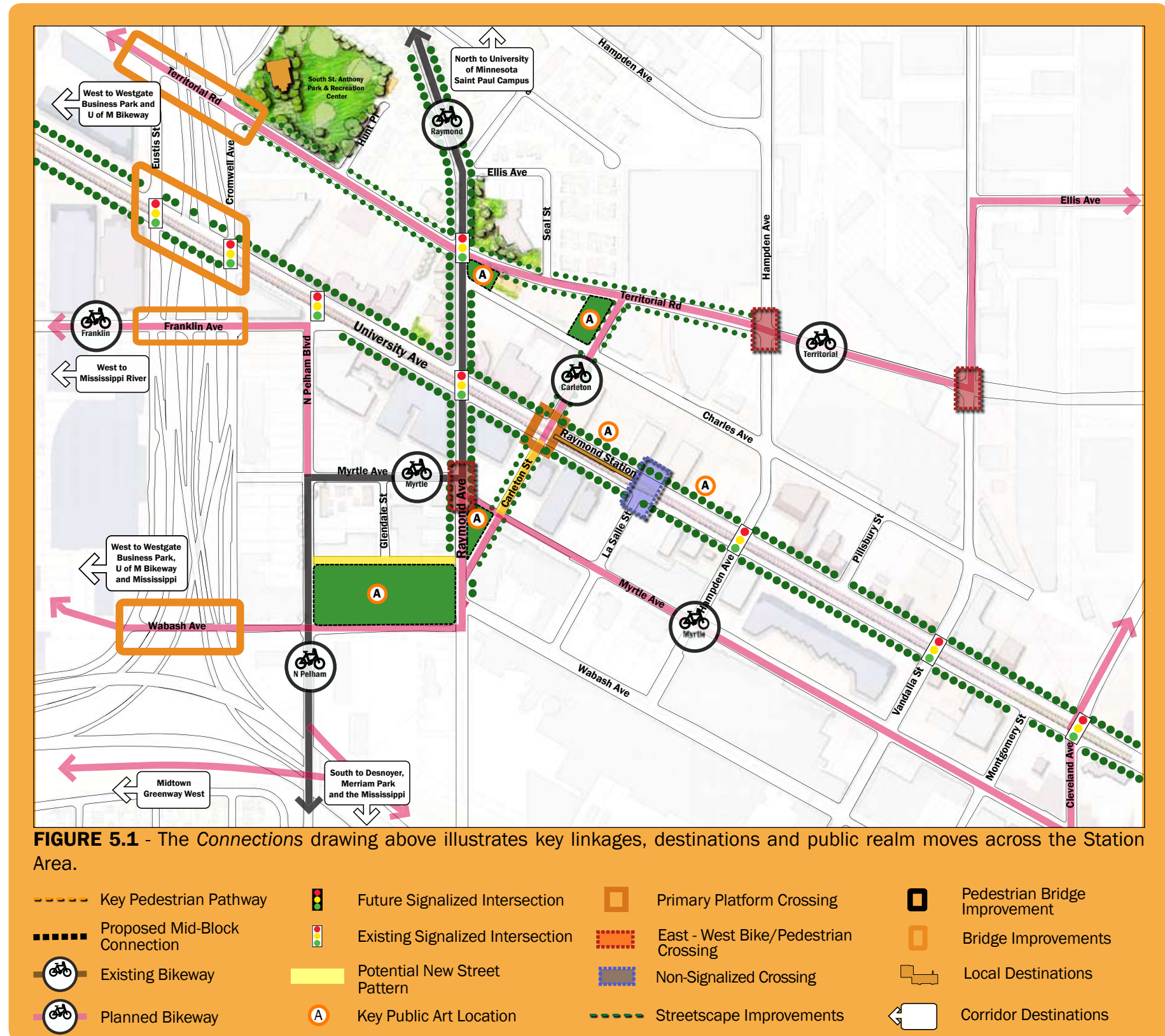

5.2 The Mobility Enhancement Area

The *Mobility Enhancement Area* diagrams (figure 5.2) illustrate the current and future hub of movement patterns within the Raymond Station Area.

Mobility Enhancement Area

An opportunity for enhancing movement around the Raymond Station occurs in three key areas. To the north and south of University Avenue, an opportunity exists to rebalance the streets in favor of pedestrians and cyclists. This will help to improve the walkability of the area, strengthening the pedestrian character of the *Historic Raymond Village* and improve the relationship between the emerging residential development and the existing employment uses in the area.

Along University Avenue and north on Raymond, strategies to enhance mobility should focus on enhancing pedestrian amenities to support the historic retail function of the area.

Special strategies for the Raymond Station Mobility Enhancement Area include:

- using landscaping and sidewalk treatments to soften the edges of between adjacent residential and industrial employment uses;
- providing landscape, lighting and streetscape treatments that both provide amenity but respect the historic character of the area;
- reintroducing sidewalks along Territorial and Myrtle Streets to make it safer to walk to and from work between the LRT; and
- providing sidewalks of 14 feet in width.

The Station Transfer Zone

The Station Transfer Zone is identified in Figure 5.2. It stretches from Carleton Street in the west to La Salle Street in the east. An opportunity exists to enhance the character of the Avenue by integrating the station facilities into the historic fabric of the Historic Raymond Village.

Special strategies for the Raymond Station Transfer Zone include:

- Ensuring that station facilities and transit related infrastructure compliment the historic character of the area; and
- Incorporating special streetscape treatments to reflect the industrial heritage of the neighborhood.

The Designated Crossings

Within the Raymond Station Mobility Enhancement Area there are a number of Designated Crossings. The Primary Platform Crossing is located at the intersection of Carleton Street and University Avenue. This will be the area's principle hub of station activity, as it links the LRT with the bus network, and acts as an important connection in the proposed open space linking the Charles Avenue Community park south to Wabash Commons.

A Non-Signalized Crossing at La Salle Street will link directly to the far end of the station platform providing additional access to the station and defining the eastern edge of the historic village's retail core.

Along Raymond Avenue there are two East - West Bike / Pedestrian Crossings at Territorial and Myrtle. These are important crossings that will provide bicycle access to the employment areas to the east and help to strengthen the existing bicycle route along Raymond.

For more detailed descriptions of the various Designated Crossings proposed for the Central Corridor, please refer to Chapter 1 of the full set of Station Area Plans.

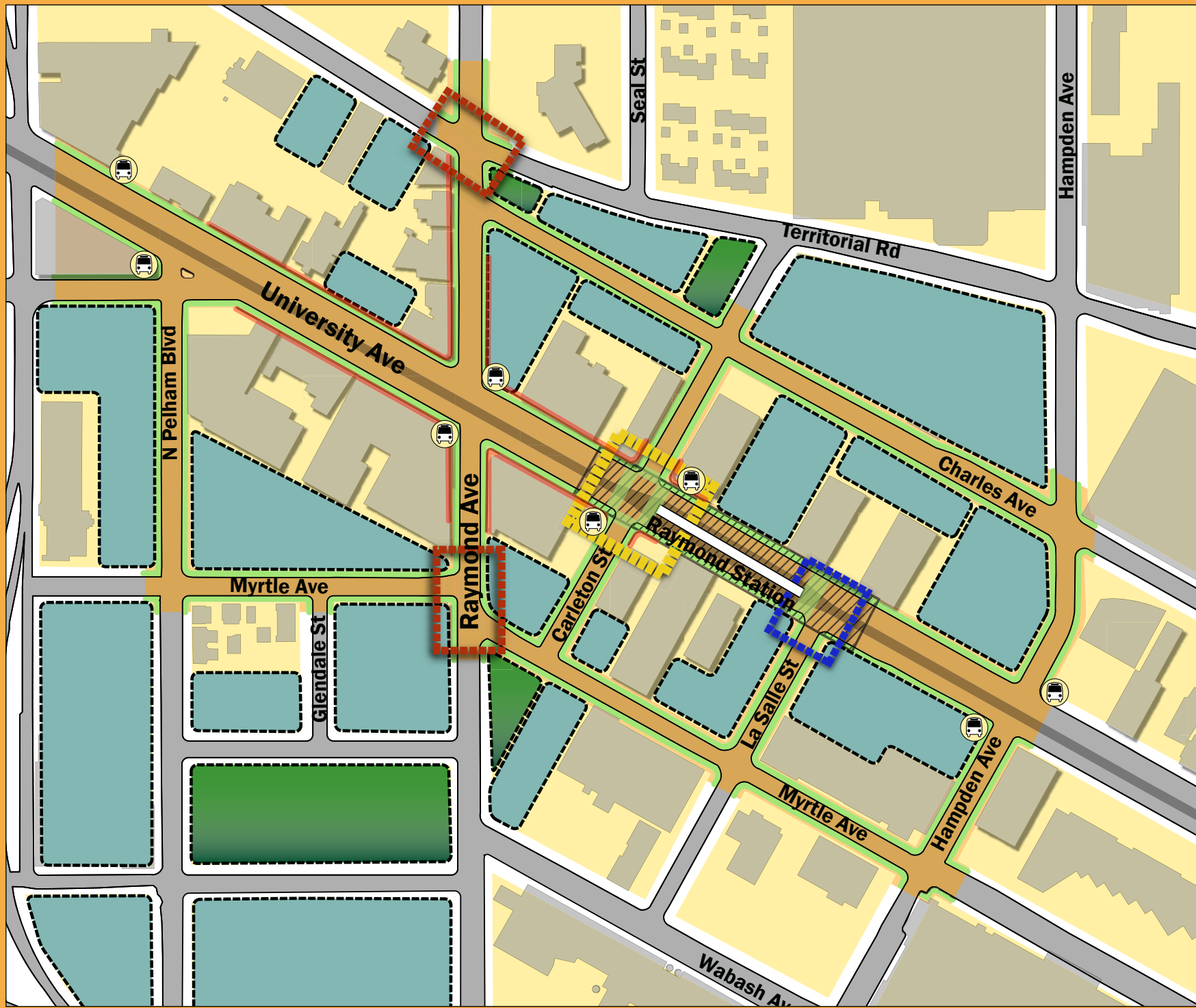











FIGURE 5.2 - The Mobility Enhancement Area illustrates the area around the station where a higher level of pedestrian activity can be anticipated.

-  LRT Platform
-  Mobility Enhancement Area
-  Station Transfer Zone
-  Bus Stop
-  Priority Active Frontage
-  Open Space Candidate Site
-  Future Development Potential
-  Primary Platform Crossing
-  Non-Signalized Crossing
-  East - West Bike / Pedestrian Crossing



Getting There

Achieving the long-term objectives set out in this document for the Raymond Station Area will require the collaboration of many local partners, investors and stakeholders and will occur over time. The following recommendations provide direction on key initiatives that are core to the success of the future Raymond Station Area.

In addition to the broader Community-Building Strategies described in the CCDS, and the Station Area Implementation Strategies set out in the Moving Forward Chapter in this series of Station Area Plan Documents, the following describes place-specific strategies for the Raymond Station Area. These considerations should be read in conjunction with the aforementioned implementation recommendations, and deemed to take precedence where discrepancies exist.

Using This Station Area Plan

The development concepts illustrated in this plan, including the location of new open spaces, each represent one of many possible development scenarios. Their purpose is to illustrate how the principles and objectives for new development, as contained within the CCDS and this Station Area Plan, could be realized over time. They are not intended to be prescriptive for evaluating future development proposals, but are examples of how the vision, goals, and objectives of this plan can be realized.

Until such time as the City is able to secure necessary resources, either through public investment or through negotiation with private developers for desired new open spaces or other public infrastructure, private property may be used for any legal use permitted under the current zoning classification, provided that the proposed use meets all applicable conditions and/or standards.

Once adopted as a component of the City of Saint Paul's Comprehensive Plan, City staff intend to pursue mechanisms, programs and partnerships that will collectively assist in realizing the vision and objectives created for each station area. The sum of the CCDS's 21 Community-Building Strategies (Section 4.3); the Getting There recommendations from individual Station Area Plans (Section 6.0); and the Station Area Plan Chapter 9 - Moving Forward, contain a range of strategies, partnerships and recommendations for assisting in realizing the strategic place-making and economic development potential of this Station Area.

Securing Raymond Network of Park Spaces

As development applications proceed, all future parkland dedication within the Raymond Station Area should be applied to the acquisition of lands for the creation of these new park spaces. This will require that land dedication be the preferred acquisition approach for future redevelopment on lands located on the future site of the park space. The future redevelopment of all adjacent parcels within the Station Area will require cash-in-lieu of dedication for the purpose of acquiring additional land. The potential may exist for new park and open spaces to be partially funded through Tax Increment Financing and/or a Regional Transit-Oriented Development "Bank", as described in Chapter 9 Moving Forward.

Strategically Market Corporate Address along Cromwell

The City of Saint Paul should undertake an economic development exercise to actively promote the strategic potential provided by the redevelopment parcels within the Raymond Station Area. This should involve identifying strategies to reduce barriers to redevelopment, including allocating funds for infrastructure and streetscaping improvements, and streamlining application review and development approval processes.

Transition Over Time

Meeting the full development potential of the Central Corridor, as conceptually illustrated in each Station Area Plan, will occur over a long period of time. Recognizing the market may not be uniformly ready to respond to the ambitious visions illustrated in each plan nor to the full extent of the Transit Opportunity Zone (TOZ) regulatory framework outlined in the Central Corridor Development Strategy, both sets of policy documents should allow for market transformation and uptake over time.

For example, a near-term development proposal that does not meet density expectations for central, strategic sites, or does not secure a shared parking agreement with a neighboring land owner, yet meets other long-term objectives such as increasing the range of available housing types, supporting economic development, increasing retail options and employment opportunities, or providing active uses at grade, should be accommodated. In these instances, proponents of development applications should demonstrate how specific physical and/or market constraints make the full range of station area objectives difficult to achieve, how the general intent and purpose of the CCDS and respective Station Area Plan will be met, and additionally how other standards are being met and/or exceeded.

The development principles matrix, outlined in Chapter 9, may also assist City officials, staff, and community members in evaluating the benefits of development proposals in terms of economic value and transit-supportive principles included in the CCDS.

Please refer to the Moving Forward Chapter of the full set of Station Area Plans for additional details.

North-East Corner of Raymond and University Should Come Forward as a TOD Demonstration Site

Given the prominence of this site and its proximity to LRT, the City and the Central Corridor Design Center should work with the owner of this triangular parcel to develop a comprehensive master site plan for its future redevelopment. The strategy should reinforce the long-term vision set out in this document, and propose concepts for transit-supportive development with defined public realm and design directions. The future viability and success of this site coming forward as a TOD Demonstration Site may in part be assisted through some combination of Tax Increment Financing, the STAR Program, and/or a Regional Transit-Oriented Development "Bank", as described in Chapter 9 Moving Forward.

Involving Local Partners

Meeting the long term objectives of the Raymond Station Area Plan will require coordination with:

Saint Anthony Park Community Council. To review development applications coming forward, promote and work towards quality development projects and meet with residents, institutions, business and property owners to discuss and document evolving community concerns and objectives for new development.

The City of Saint Paul Heritage Preservation Commission. Will review the design and integration of all new development within the University-Raymond Commercial Historic District.

Saint Paul Port Authority. A significant portion of the infill and redevelopment potential within the Raymond Station Area will require direct consultation with the Saint Paul Port Authority.

St. Paul Smart Trips. As the Transportation Management Organization for the City, Smart Trips should work with local partners to provide information about parking in the corridor, and to promote opportunities for walking, bicycling, and transit.

Midway-Chamber, University Avenue Business Association and other business groups. To ensure the interests of area businesses and property owners are adequately represented through comprehensive policy framework reviews.

University UNITED. To assist in the ongoing review of development applications in conjunction with District Council offices, and to continue enriching dialogues around improving the character and quality of area planning and development. U-Plan, a program of University UNITED, will provide technical support services to community groups, small businesses, and other stakeholders.

Central Corridor Funders Collaborative. To assist in securing resources for community improvement projects.

Individual property owners. Consultation and discussion with property owners, particularly with the Saint Paul Port Authority – a potential economic development partner – should begin well in advance of submission of development applications, and continue through the development approvals process.

The Central Corridor Design Center. The Central Corridor Design Center is an initiative by the City of Saint Paul to apply the proven practices of the Saint Paul on the Mississippi Design Center along the Central Corridor. Its mission is to be a champion and advocate for the principles and vision of the Central Corridor Development Strategy as they guide public and private investment in the corridor.

The CCDC will be involved in design review and guidance of the Central Corridor LRT and other public realm improvements; design development conversations with large and small property owners; technical assistance to small businesses to redesign their facilities to take advantage of the LRT and proposed public improvements; providing leadership in energy and environmental design; and education and training of City staff, consultants, developers and property owners in maximizing transit-oriented design opportunities along the Corridor and in the neighborhood.