



TASTE OF RONDO RESTAURANT

976 Concordia Ave
St. Paul, MN 55104
p. 612.268.8441
TasteOfRondo@gmail.com

Table of Contents

I. Executive Summary

II. Description of Business

Mission Statement

Company Ownership/Legal Entity

Exterior & Interior

Hours of Operation

III. Industry Analysis

Our Position

Market Analysis & Target Market

Competitors

IV. Marketing Plan

Products & Services

Sample Menu

Restaurant Concept

Advertising & Promotion

V. Management Plan

Organizational Structures & Roles

VI. Conclusion

Keys to Success

VII. Appendix

Letters of Support

Floor Plan

Scope of Work

MDH Food & Beverage Report on Plan

City of St. Paul Non-Confirming Use Permit

Taste of Rondo Architecture Review Set

Resolutions of Approval for City Grant/ Loan Funding

DSI Approval of Definition of Restaurant

Executive Summary

The Taste of Rondo Restaurant is a family owned establishment located in the historic neighborhood of Rondo in St. Paul, Minnesota. Our emphasis will be to provide a unique dining experience by featuring nourishing, creative, and soul food dishes that are both tasty and healthy. Our focus is to engage our customers by reminding them of the historic importance of the once vibrant, vital, independent community that was displaced by the construction of I-94 in the 60's one meal at a time. The Taste of Rondo Restaurant will give customers a sense of pride and belonging in this legendary community. Our concept will stand out from other restaurants in the area because of the unique design, thoughtful décor and historical Rondo landmark. We will offer a dining experience and use of space like no other with the many versatile features of the business.

Description of Business

Mission Statement

To provide a quality, appealing and unique dining experience, while helping revitalize our community through job creation and enhancing cultural awareness. Our goal is to sustain a satisfying family-oriented environment for our customers and employees in a historically themed restaurant that contributes to the economic vitality of the community to which it serves by transforming first time customers into repeat customers.

Company Ownership/Legal Entity

Charles Carter is the sole owner of the Taste of Rondo Restaurant and has been granted a change of nonconforming use from private club to restaurant and meeting space and will be doing business as Taste of Rondo LLC. This will become a new restaurant business that will seek to acquire a full-service liquor license.

Exterior & Interior

The Taste of Rondo Restaurant will be a 'Casual Style Dining' establishment located in the heart of the Rondo community at 976 Concordia (Old Rondo) Avenue and will be developed in a manner that will commemorate the history and legacy of the Rondo community prior to the construction of Highway I-94 that destroyed a vibrant predominately black community in the late 1950's into the early 1960's.

To keep life and dining interesting, our exterior and interior design will utilize artwork that will reflect the community influences of Rondo. Use of original and replicated artifacts, photos and other design elements that are core to the tapestry of this historic community will illuminate the rich heritage and traditions of the Rondo legacy. Modern technology will be infused throughout the restaurant - that could include the use of 'Touchscreen Food Vendors', 'Tablet Restaurant Management', HD monitors for multiple viewing and visual uses, etc. - to provide operational efficiencies and create a unique dining experience that is welcoming and comfortable for the Taste of Rondo customers. Proposed menu items will be themed after descendant luminaries, historical monuments and geographies from the Rondo community, pre I-94 era.

The emphasis of the Taste of Rondo's menu items will feature a creative ethnic variety of 'Plant Based', 'Authentic' and 'Street Foods' that are healthy and tasty while also representing some historical dishes of the Rondo community pre I-94 era.

It will be our goal to appeal to all age groups and a variety of cultural backgrounds.

Adult guests will be able to enjoy beer and or wine while they wait for their food order or just to take a load off after a full day of business or work. Comfortable dining music will be played from the audio/visual station and live music during special events.

Hours of Operation

The Taste of Rondo Restaurant offering food service on Monday through Sunday from 7:00AM to 10:30PM. Options to work within the hours of operations with all applicable licensees.

Industry Analysis

Our Position

Our strategy is simple: Honor our past to revitalize our future. The neighborhoods north and south of Rondo Avenue, extending south into today's Summit-University neighborhood and north to University Avenue, were always diverse. By the 1950s about 85 percent of Saint Paul's African-American population lived in the neighborhoods. More than 600 African American families lost their homes. Numerous businesses and institutions were also lost. We intend to succeed by giving our customers a combination of excellent and interesting food in a community that highly anticipates, the opening of a much needed, black owned Restaurant. We will focus on maintaining quality and establishing a strong identity in our community.

Market Analysis / Target Market

The Taste of Rondo intends to cater to a wide group of people. We want everyone to feel welcomed and relaxed in a comfortable environment. It is our goal to have menu selections that are appealing to everyone. In reviewing our target analysis, we have defined the following groups as targeted segments:

- ✓ **Families:** This group is continuously growing along with neighborhood and evolving with new developments and the revitalization of older homes which is changing the landscape of the Rondo neighborhood. The perfect place for a family dinner. Families will come for the accommodating menu and friendly service. The excellent value within the menu options will keep The Taste of Rondo in favor with the parents.
- ✓ **Community Leaders and Elected Officials:** This segment has an overwhelming number of supporters simply because it is a FIRST-TO-MARKET concept that is adopting the importance of the Rondo legacy, its history and the positive direction the Rondo 'mantra' has grown into and will continue to grow in the years to come. The Taste of Rondo will be sought after as a place where people can meet each other, eat, drink and network. This demographic is very successful but balanced group of constituents.
- ✓ **Educators:** There are several schools in the community which employs hundreds of individuals who are looking for our type of dining experience. The Taste of Rondo's mission is to revitalize the community through our food, to enhance cultural awareness, and to provide an educational impact as it relates to the historic importance of this community.
- ✓ **Churches:** This group of distinct persons has been an anchor in the community and city. This group is made up of hundreds of highly employed and highly connected individuals that

impact and support change in this community. Their focus on economic sustainability, education, political and spiritual awareness as well as physical and mental health ties directly to our beliefs. We will attract them with our décor and layout. This demographic may not be big on contributing to bar sales, but our menu, striking artwork, excellent service and engaging clientele will confirm the feeling of being part of the fabric of Rondo.

Competition

There are several new restaurants opening in the community that could present minimal competition. However, we believe the Taste of Rondo will have a competitive edge over other restaurants because for the following reasons:

- ✓ **Location:** The Taste of Rondo is located on a frontage road just 2 blocks from the I94 and Lexington exit and is less than half a mile from the future soccer stadium. There are no other restaurants of this caliber within a ½ mile circumference in the community.
- ✓ **Concept:** The name Rondo has become a household name within the community and abroad and continues to gain visibility, respect and an overall sense of opportunity that will continue to grow as the community develops
- ✓ **Venue:** The Taste of Rondo will shout out features not many other eating establishments can confess to. A large outdoor patio with grilling station, an intimate roof top patio, entertainment space, private meeting space and movie room.

RESTAURANTS IN 5 BLOCKS

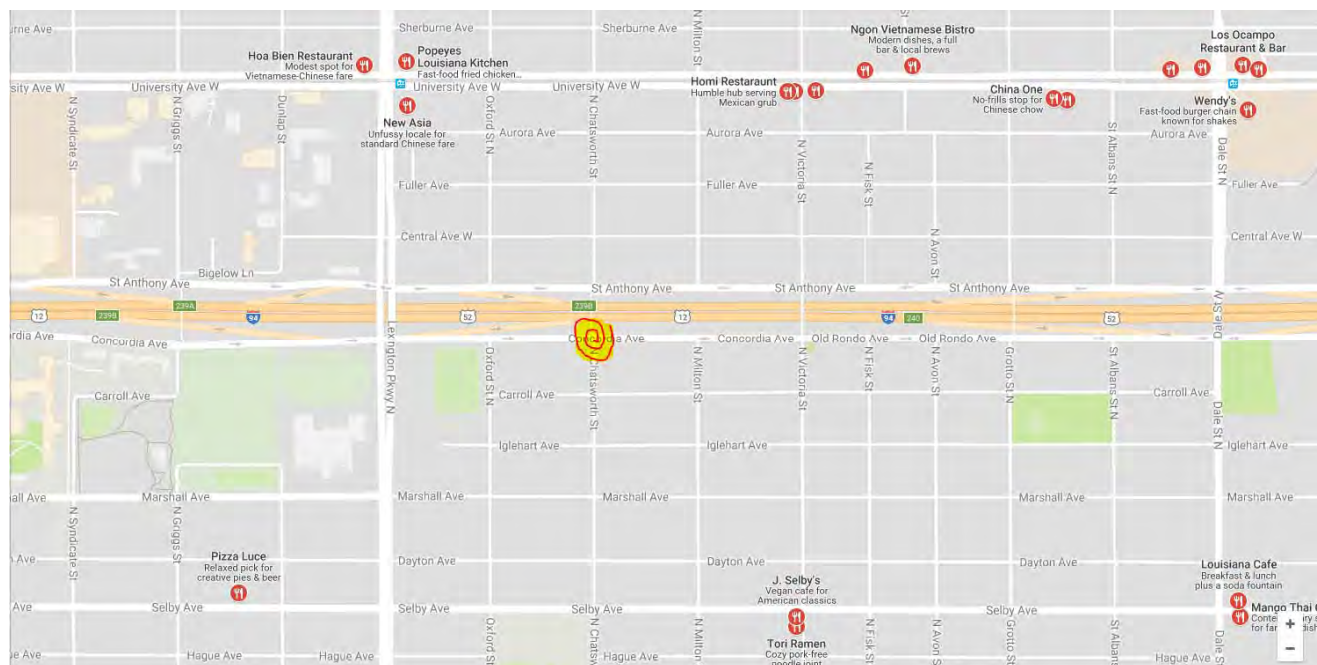

TASTE OF RONDO RESTAURANT

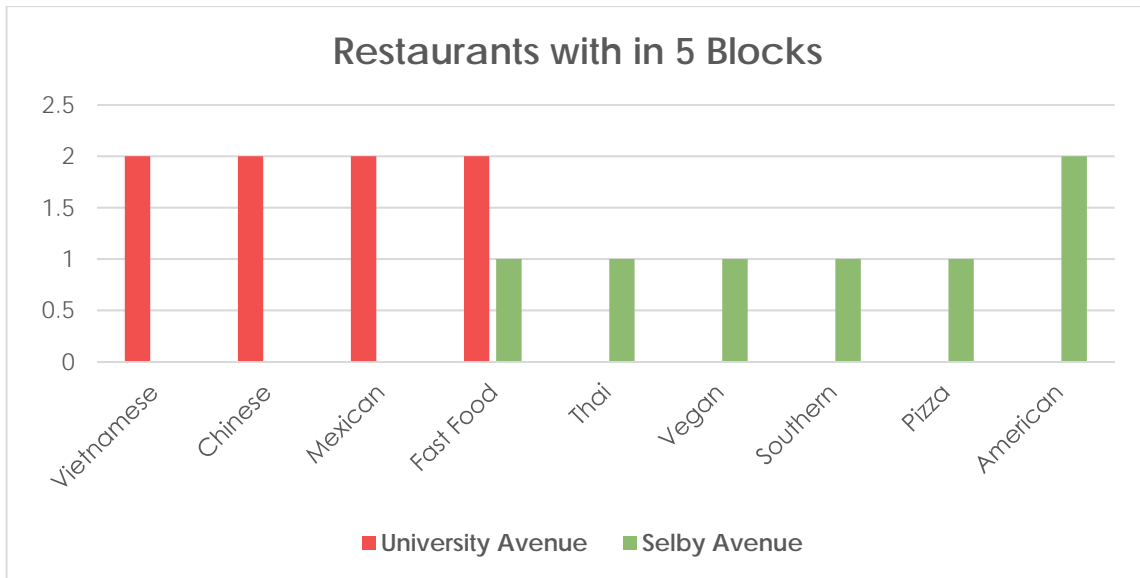

Fare	Restaurant	Location
American	Louisiana Café	Selby Ave
American	Tori Ramen	Selby Ave
Chinese	New Asia	University Ave
Chinese	China One	University Ave
Fast - Food	Popeyes Louisiana Kitchen	University Ave
Fast - Food	Wendy's	University Ave
Fast - Food	Subway	Selby Ave
Mexican	Homi Restaurant	University Ave
Mexican	Los Ocampo Restaurant & Bar	University Ave
Pizza	Pizza Luce	Selby Ave
Southern	Revival	Selby Ave
Thai	Mango Thai Cuisine	Selby Ave
Vegan	J. Selby's	Selby Ave
Vietnamese	Ngon Vietnamese Bistro	University Ave
Vietnamese	Hoa Bien Restaurant	University Ave

Marketing Plan

Products and Services

The Taste of Rondo Restaurant will be open for breakfast, lunch and dinner. One of our competitive advantages will be the menu, that will be simple, but changing every 2-3 months. Our chef will have a strong emphasis on preparing healthy dishes, recognizing the trend within the restaurant industry for the demand of healthy cuisine. Product quality will remain as one of our top priorities. We will keep a small group of regular items on the menu and feature a chef's recommendation that will be offered with many of the meals ordered. This will help us to reduce waste, plan ingredients and purchasing inventory. All menu items will be moderately priced for the area.

During the busy summer months, customers will be able to indulge in our significantly sized outdoor patio. We will offer a special summer menu, featuring lighter fare, exotic drinks, as well as non-alcoholic offerings. The patio and green space garden area setting will be a fun and casual atmosphere for the summer crowd.

The Taste of Rondo will also offer the perfect place when our customers need that 'little extra' personal touch. They can host business meetings, have a place for a quiet conversation, or for many special occasions.

Great service is very important to us. We will create an appealing and entertaining environment with unbeatable quality. The management and servers will handle every detail to make customers feel special and valued. Therefore, the execution of our concept is one of the most critical elements of our plan. While we are not striving to be the lowest-priced restaurant, we are aiming to be the highest value leader.

Sample Menu

Taste of Rondo Sample Menu Options

Build Your Own Omelet

Any three ingredients below folded into three fresh eggs. Served with your choice of freshly delivered sourdough white, multi-grain, or rye toast. (Extra ingredients \$2.00 each) \$8.95

Bacon	Sausage	Cajun Sausage
Swiss Cheese	Cheddar Cheese	American Cheese
Pepper Jack Cheese	All-Natural Ham	Green Pepper
Tomato	Cilantro	Broccoli

Pancake Combos \$6.50

Breakfast Combos \$6.50 - \$12.00

Appetizers

- **Roger Anderson's Fried Green Tomatoes** Cornmeal Crusted, Remoulade **V-** \$8
- **Rondo Wings** Choice of Hot or Southern Sauce, Bleu Cheese Dressing, Celery – 6 / \$8 – 10 / \$12
- **Carroll Avenue Shrimp** Orange Marmalade, Hot Mustard – \$9
- **Debbie Montgomery Catfish Basket** Cornmeal Crusted Marinated Catfish, Cajun Fries, Jalapeno Tarter – \$10
- **Milton Ave Wontons** Cajun Pork, Slaw, Jalapeno Cream Cheese, Sriracha Thousand Island, – \$10
- **Smothered Cajun Fries** Signature Fries, Shredded Cheese, White Chicken Chili, Green Onions, Sour Cream-\$10
- **Stuffed Portabella Mushrooms** Baked with Rice Blend, Spinach, Parmesan Cheese- \$9
- **Baking Powdered Biscuits** Served with Honey Butter – 2 /\$4 – 3/\$5 *Add Cream Gravy – \$1*
- **Victoria Ave Crab Cakes** Lump & Sweet Claw Crab Meat, Trinity, Remoulade – \$12
- **Selby Ave Brisket Sliders** Beef Brisket, Caramelized Onions, Pepper Jack Cheese, with Cajun Fries – \$10

Soups

- **Gumbo** Chicken, Andouille, Trinity, Okra, Shrimp, Dark Roux with French Bread – Cup – \$6 / Bowl – \$10
- **Crab Bisque** Claw Crab Meat, Sherry Cream, Shredded Egg with Crackers – Cup – \$6 / Bowl – \$10
- **White Chicken Chili** Thick & Hearty, Jalapeno Cream Cheese with Flour Tortilla – Cup – \$6 / Bowl – \$10

Salads

- **Fredrick L. McGhee Blackened Catfish** Blackened Catfish, Mixed Greens, Sweet Potato Chips, Grape Tomatoes, Red Onions, Candied Pecans, Goat Cheese, Champagne Vinaigrette – \$15

- **Coconut Shrimp** Coconut Shrimp, Mixed Greens, Bacon, Grape Tomatoes, Red Onions, Shredded Egg & Carrot, Cucumber, Goat Cheese, Candied Pecans & Creole Honey Mustard- \$15
- **Grilled Chicken Salad** Grilled Chicken, Mixed Greens, Candied Pecans, Crumbled Bleu Cheese, Red Onions, Strawberries, & Balsamic Vinaigrette - \$15
- **Caesar** Chopped Romaine, House Croutons, Egg, Caesar Dressing, Parmesan Cheese, & Fried Tabasco Onions \$7/\$11 *Add Grilled Chicken – \$4 Add Grilled Shrimp – \$5*

Entrees Add a Cup of Soup or House Salad – \$5

- **Jambalaya** Chicken, Andouille, Jalapeno Pork Sausage, Pork Shoulder, Shrimp, Trinity & Rice -\$19
- **James W. Crump, M.D. Southern Fried Chicken** Our Signature Brined & Marinated Juicy Half Chicken, Served with Smothered Greens – \$18
- **Blackened or Deep Fried Catfish Filet** Covered with Crawfish Etouffee Sauce, Served with Red Beans & Rice – \$19
- **Cut Pork Chop** Full Pound, Bone in, Brined, Smoked & Char-Broiled, with House-made Bourbon Mustard BBQ Sauce, And Mashed & Gravy- \$22
- **St. Louis Ribs** Hickory Smoked, Braised & Char-Broiled Ribs Served with Corn – \$17 / \$26
- **Shrimp n’ Grits** Gulf Shrimp, Andouille, Trinity, Stone Ground Cheddar Grits, Louisiana Hot Sauce Butter – \$19
- **Pot Roast** Slow Cooked Beef Roast, Mashed Potatoes, Vegetables, Brown Gravy – \$17
- **Country Fried Steak** Buttermilk Brined Tri-tip Sirloin, Mashed Potatoes & Cream Gravy – \$18

Sides

- Cheddar Grits \$4
- Brussel Sprouts \$4
- Cajun Fries \$5
- Collard Greens \$4
- Corn Bread & Honey Butter \$2
- Crock of Mac n’ Cheese \$8
- Deviled Egg Potato Salad \$5
- Mashed Potatoes and Gravy \$4
- Red Beans, Andouille & Rice \$5

Restaurant Concept

The Taste of Rondo Restaurant, a NEW 'Casual Style Dining' eating establishment is in the heart of the Rondo community at 976 Concordia (Old Rondo) Avenue. The exterior and interior will be designed to commemorate the history and legacy of the Rondo community prior to the construction of Highway I-94 that destroyed a vibrant predominately black community in the late 1950's into the early 1960's.

The emphasis of the Taste of Rondo's menu items will feature a creative ethnic variety of Plant Based, Authentic and Soul Food that are healthy and tasty while also representing some historical dishes of the Rondo community pre-194 era. It will be our goal to appeal to all age groups and a variety of cultural backgrounds.

There will be a full-service bar and a small designated entertainment area (portable riser and audio/visual station) constructed within the dining room. Adult guests will be able to enjoy refreshments while they wait for their food order or just to take a load off after a full day of business or work. Comfortable dining music will be played from the audio/visual station and live music during special events.

We have identified the need for a historic community restaurant and have gained the support of our neighboring residents, our State Representative, Councilmembers from the city of St. Paul, and numerous entities of the Rondo community.

*See our appendix of support letters for changing the non-conforming usage to our proposed neighborhood restaurant. *

Advertising & Promotion

Introducing the Taste of Rondo Restaurant to the Twin Cities and beyond is an integral element to the success of the business. We will utilize many marketing strategies and channels to ensure we have provided opportunities for people of all backgrounds and geographies to be well informed of the Taste of Rondo Restaurant and what we should offer. Marketing strategies and channels to be employed include but are not limited to:

1. Taste of Rondo website
2. Social media
3. Radio and Commercials (television)
4. Restaurant promotions/specials
5. Local print media (i.e. newspaper ads)
6. Street team marketing (flyer/poster distribution)
7. Cross promotional opportunities with other businesses
8. Sponsorships
9. Word of mouth

Management Plan

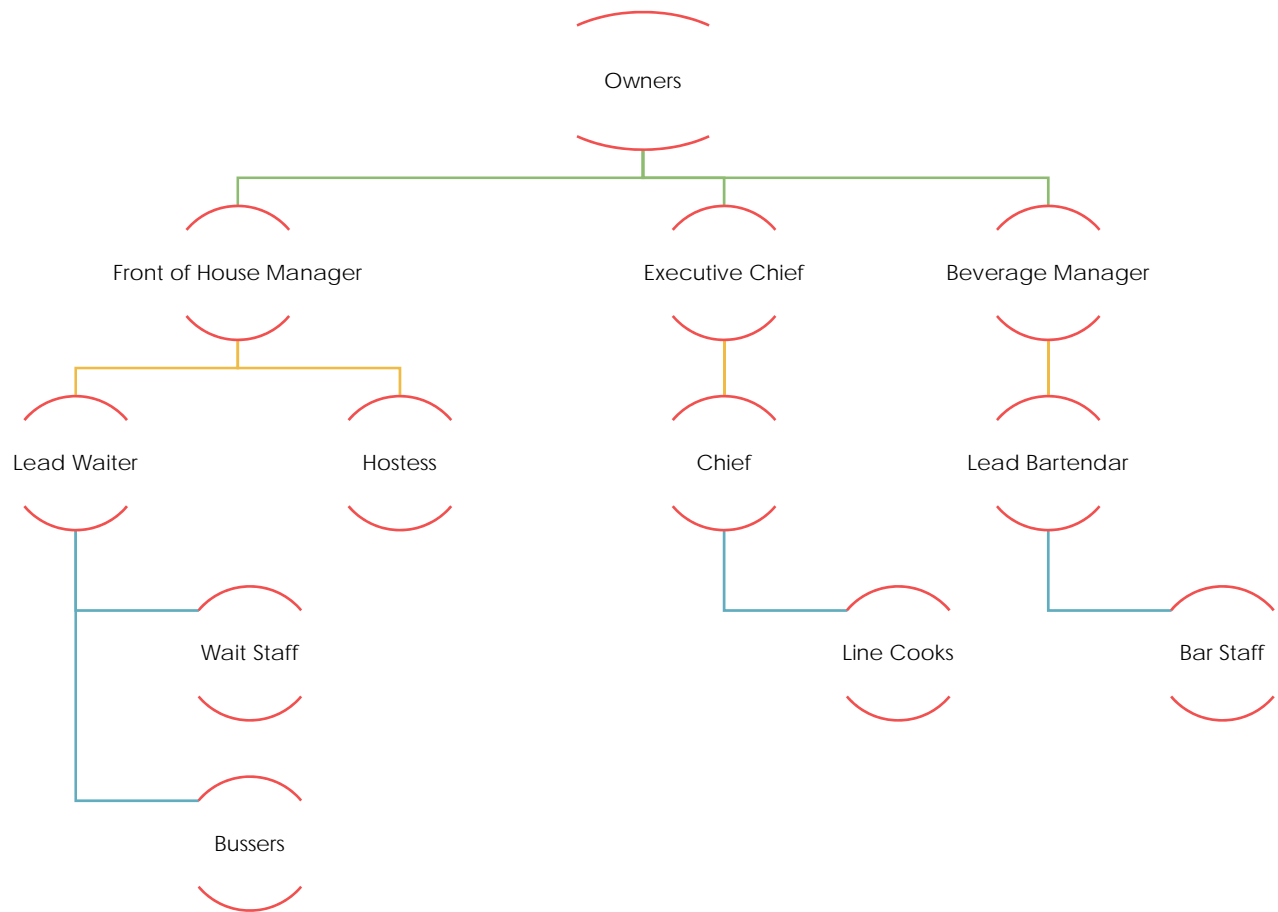

Taste of Rondo Organizational Structure & Roles - Tentative

Definition of Roles within Organizational Structure

UPPER MANAGEMENT

OWNERSHIP:

- responsible for the business finances;
- ultimate decision makers and are accountable for the general direction of the business;
- obtain a license and insurance;
- responsible for hiring and terminating employees;
- designate employee incentives, including health care and benefits;
- establish rules for employees and customers, such as age restrictions and clothing requirements;
- being hospitable and providing a customer-friendly atmosphere is among the most important duties of being a restaurant owner.

GENERAL MANAGER:

- responsible for the day-to-day operations of the business, including hiring, training and overseeing the staff;
- making sure that the restaurant is maintained in proper operating condition;
- ensuring that things run smoothly when the restaurant is open;
- responsible for totaling up the daily receipts;
- making sure that the restaurant adheres to all legal requirements and communicating with the restaurant owner;
- for customers and vendors, a restaurant manager is essentially the "face" of the business.
 - Any complaints concerning food quality, customer service or maintenance are usually addressed by him or her.
 - Food vendors and service providers routinely deal with the manager to acknowledge receipt of goods and services, or to implement any changes to future orders.
- conducts inventories of current supplies and calculates the next food and supply orders accordingly
- doing the promotion and marketing for the business;
- supervising, recruiting, and training the staff;
- setting and regulating budgets;
- oversee the kitchen stock levels and order supplies.
- handle all of the issues associated with licensing and hygiene.
- In charge of the menu planning as well.

ASSISTANT MANAGER:

- hire or terminate employees;
- involved in training;
- oversee employee work to determine if its quality is appropriate or if improvements need to be made;
- conducting employee reviews;
- making up work schedules;
- or acting as a go-between communicator between employees and upper level management or owners.
- takes the initiative to improve current problems; and
- adheres to company policy as well as obey your manager's instructions while solving problems and gaining new skills.

FRONT OF HOUSE OPERATIONAL STRUCTURE**FRONT OF HOUSE MANAGER:**

The front-of-house manager is responsible for the restaurant's dining area and the staff that supports the front of the house. This includes:

- act as Manager on Duty in absence of the Assistant Manager and General Manager;
- ensures that guests have a pleasant and memorable dining experience;
- overseeing the front of house staff setting up service;
- waiting on customers;
- interacting with the kitchen staff;
- responsible for the beverages and bar area; and
- banquet or catering operations.
- monitors setup, maintenance, cleanliness and safety of dining areas;
- supervises and trains the Dining Room Staff;
- must be able to complete opening and closing duties/checklists in a timely fashion;
- must coordinate food service between kitchen and dining staff.

HOST OR HOSTESS:

- greet guests, take them to their table and provide them with silverware and a menu;
- monitor the table rotation;
- keep track of which tables are cleaned and available for new guests;
- answer the phone;
- take reservations;
- take-out orders;
- ensure that the guests are made comfortable and kept informed of the status of their orders or wait times
- monitoring the open dining sections of the restaurant for empty and cleaned tables,

- estimating wait times for guests,
- monitoring the guest waiting list,
- and ensuring that the needs of the guests are met while they are waiting; and
- make any necessary changes to the dining room occupancy chart.

SERVER:

- taking orders and delivering food;
- prepares the tables;
- laying out napkins and utensils;
- making sure the condiments are refilled;
- performing all other preparation tasks;
- staying updated on current menu choices, specialties and menu deviations;
- knowing if the kitchen staff is running out of any items;
- handle the table bookings;
- direct customers to their tables;
- presenting menus;
- suggesting dishes;
- assisting in drink selection;
- informing customers about food preparation details;
- communicating specific customer needs to the cooks;
- maintaining proper dining experience;
- delivering items;
- fulfilling customer needs;
- offering desserts and drinks;
- removing courses;
- replenishing utensils;
- refilling glasses;
- properly open and pour wine at the tableside;
- obtaining revenues, issuing receipts, accepting payments and returning the change;
- performing basic cleaning tasks as needed or directed by supervisor;
- filling in for absent staff as needed;
- assisting with special events as needed;
- greet all guests and owners warmly with an appropriate greeting.

BEVERAGE MANAGER:

- ensuring proper control, counting, and purchasing inventory of bar stock;
- counts inventory of the bar's products;
- keeps a watchful eye on drastic drops or rises in inventory, as that may be a sign for foul play or carelessness behind the bar;
- regularly counts wine, liquor, and bottled and draft beer to ensure to stock the proper amount;

- puts in orders to stock the proper amount.
- the bar manager may put in orders with one or more alcoholic beverage representatives or merchants on a recurring basis.
- must have solid customer service, speaking, problem-solving, leadership, organizational and managerial skills;
- computer skills experience with recipe and menu database software, inventory management software and point of sale (POS) software;
- training for of liquor handling, preferred guest interaction, and money-handling policies.

HEAD BARTENDER:

- in charge of the overall bar area and reports to the bar manager or bar owner;
- controlling the bar costs;
- maintaining the cost flow of alcohol;
- weekly evaluation of bar reports;
- make suggestions on each bartender's "free pour" technique to maintain quality and cost;
- performing drink demonstrations to make sure other bartenders can prepare the drinks on the menu;
- creating drinking specials
- unload any overstocked products that need to be use;
- ordering and stocking inventory;
- must maintain high standards of cleanliness and safety;
- take nightly inventory of the products and supplies behind the bar and restock or order accordingly;
- manage bar staff and educate them on the safety and work procedures that the bar maintains;
- creates and enforces the work schedule;
- deals with customer complaints and rowdy clients; and
- ensures all bartenders check for the proper identification for alcohol consumption and make drinks properly.

BACK OF HOUSE OPERATIONAL STRUCTURE

EXECUTIVE CHEF:

The executive or head chef is responsible for back-of-house operations which intel's productivity of the kitchen staff, as well as managing the sous chef and chef de partie. This includes:

- hiring and training kitchen staff;
- creating menu items;
- sourcing and purchasing foods and helping determine the prices for meals;
- ensure that quality culinary dishes are served on schedule and to see that any problems that arise are rectified;
- approving all prepared food items that leave his or her kitchen;
- productivity of the kitchen staff, as well as managing the sous chef and chef de partie
- modify and create new menus as needed;

- may also be called upon to use this time to create a wide variety of new dishes for his or her kitchen;
- performs many administrative duties, including ordering supplies and reporting to the head of the establishment.

SOUS CHEF:

- does most the actual cooking in a kitchen;
- prepares everything from main dishes to salads, breads, pasta and even desserts;
- storage and disposal of food (both incoming stock and leftovers);
- assist in unloading delivery trucks and ensuring that food is stored in the appropriate conditions;
- determines if leftovers of either prepared or partially prepared food can be reused or if they must be disposed of;

LINE COOK:

- Food preparation responsibilities include:
 - preparation of ingredients and assembling dishes according to restaurant recipes and specifications;
 - preparation of his or her station before the start of each service;
 - ensuring all the supplies that will be needed for the night are available and ready for use;
 - this includes preparing some items in advance, or performing simple tasks such as stocking the station with plates and bowls;
 - chopping vegetables, butchering meat, or preparing sauces
- Meal service cooking responsibilities include:
 - preparing the items requested from his or her station;
 - working with other cooks in the kitchen to make sure that food is ready at the right time, in the right order so that it arrives at the customers table ready to eat and at the right temperature.
 - A line cook will often be directed by a Sous Chef or Executive Chef as he prepares food.

BUSSERS:

- ensures that empty tables are ready to receive new guests;
 - When a party departs bussers:
 - remove dirty dishes;
 - sanitize the table;
 - add fresh place settings;
 - fill water glasses or deliver complimentary snack;
- assists servers by refilling drinks for guests or delivering trays of food to the table.
- delivers clean dishes to the cook or servers' station;
- empties trash containers;
- refills ice bins and;
- performs general cleaning chores.

Conclusion

Keys to Success

Our strategy is simple: Honor our past to revitalize our future in doing so, we intend to succeed with the anticipated support from a massive group of community stakeholders, businesses and organizations by providing a combination of excellent and interesting food options in a welcoming and comfortable environment that appeals to a wide and varied group of successful people. We will focus on maintaining elevated quality and establishing a strong identity in our community.

Appendix

Letters of Support

Floor Plan Layout

Scope of Work

MDH Food & Beverage Report on Plan

City of St. Paul Non-Confirming Use Approval

Architecture Review Set Drawings

Resolutions of Approval for City Grant/ Loan Funding

DSI Approval Letter for Definition of Restaurant



**SUMMIT-UNIVERSITY
PLANNING COUNCIL**

**Board of Directors
2018**

Chair

Angela Burns

Vice Chair

Mike Foley

Secretary

Megan Jaunich

Treasurer

Eric Ebbesen

**Chair, Neighborhood
Development**

Mary Morris

**Chair, Communications and
Outreach**

Garry Nordenstam

**Chair, Community
Improvement and Safety**

Judith Tande

Ramsey Hill Association

Martha Tilton

Unity Church Unitarian

Leetta Douglas

ASANDC

Jonathan Palmer

Hallie Q. Brown

Melvin Giles

UFGA

Daria Caldwell

Daniel Yudchiz

Jean Muller

Ibrahim Kamia

Marvin Scroggins

Jason Shiggs

Galen Benshoof

March 7, 2019

Katie Burger
Executive Assistant
St. Paul City Council and City Clerk
15 West Kellogg Boulevard, Suite 310
Saint Paul, MN 55102

Dear Ms. Burger,

The Summit-University Planning Council supports Taste of Rondo's application for a Restaurant Liquor License and Type A Entertainment License for their restaurant located at 976 Concordia Ave.

The Summit-University Planning Council voted in favor of the licenses at our March 6, 2019 Board meeting (this was the date of our rescheduled February meeting).

Please feel free to contact me if you have any further questions.

Thank you,

Jens Werner
Executive Director
Summit-University Planning Council
627 Selby Ave Suite A
Saint Paul, MN 55102

Rena Moran
State Representative

Ramsey County



Minnesota House of Representatives

October 18, 2016

Anthony Johnson – City Planner
Planning & Economic Development
25 W. 4th St., Suite 1400
Saint Paul, MN 55102

To whom it may concern:

Please use this letter as demonstration of support for the LEX's application to change its existing 'non-conforming use' to become a *restaurant establishment* located at 976 Concordia Avenue, St Paul, MN 55104. It is my belief a restaurant of this magnitude, to be operated in a historic building and by members of the Rondo community, will significantly contribute to the continued growth and economic development of the Summit-University geography.

I will take great pride and pleasure in knowing my support will assist in the decision to approve the 'change of use' application, that will ultimately allow The LEX to provide residents of the Rondo community and abroad with an additional food and beverage outlet they can look forward to patronizing.

Thank you in advance for your consideration.

Sincerely,

A handwritten signature in cursive script that reads "Rena Moran".

Rena Moran
State Representative



October 19, 2016

Anthony Johnson – City Planner
Planning & Economic Development
25 W. 4th St., Suite 1400
Saint Paul, MN 55102

Mr. Johnson:

I write in support of The Lex's application to change its existing 'non-conforming use' to become a **restaurant establishment** located at 976 Concordia Avenue, St Paul, MN 55104. This new community gathering place, to be located in a historic building and operated by members of the Rondo community, will significantly contribute to the continued growth and economic development of the Summit-University geography.

I urge the city to support this effort.

Thank you for your consideration.

Sincerely,

A handwritten signature in cursive script that reads "Toni Carter".

Toni Carter

Community Stabilization Project



"Tenant Stability Leads to Community Stability"



10/17/2016

Anthony Johnson- City Planner
Planning & Economic Development
25 W. 4th, Suite 1400
Saint Paul, MN 55102

To Whom it May Concern:

On behalf of Community Stabilization Project, please use this letter as demonstration of support for the LEX's application to change its existing Non Conforming use to become a restaurant establishment located at 975 Concordia Avenue, St Paul, MN 55104. It is our belief a restaurant of this magnitude, to be operated in a historic building and by members of the Rondo community, will significantly contribute to the continued growth and economic development of the Summit-University geography.

We will take great and pleasure in knowing our support will assist in the decision to approve the change of use application, that will ultimately allow the LEX to provide residents of the Rondo community and abroad with an additional food beverage outlet they can look forward to patronizing.

Thank you in advance for your consideration.

Sincerely,

Carolyn Brown Co/ Director

Signature: _____

Date: _____

Community Stabilization Project
501 N. Dale St Ste. 203
Saint Paul, MN 55103
Phone:(651) 225-8778
Fax: (651) 225- 4160



OSIRIS
ORGANIZATION

Bill Roddy
Co-Founder &
Executive Director

October 14, 2016

Anthony Johnson – City Planner
Planning & Economic Development
25 W. 4th St., Suite 1400
Saint Paul, MN 55102

To whom it may concern:

On behalf of Osiris Organization, please use this letter as demonstration of support for the LEX's application to change its existing 'non-conforming use' to become a restaurant establishment located at 976 Concordia Avenue, St Paul, MN 55104. It is our belief a restaurant of this magnitude, to be operated in a historic building and by members of the Rondo community, will significantly contribute to the continued growth and economic development of the Summit-University geography.

We will take great pride and pleasure in knowing our support will assist in the decision to approve the 'change of use' application, that will ultimately allow The LEX to provide residents of the Rondo community and abroad with an additional food and beverage outlet they can look forward to patronizing.

Thank you in advance for your consideration.

Sincerely,

Bill Roddy

Printed Name

Bill Roddy

Signature

10-14-2016

Date

broddy@osirisorganization.org 612-716-7002 <http://osirisorganization.org>

6702 Kara Drive, Eden Prairie, MN 55346

AFRICAN AMERICAN COMFOARTS, LLC
714 University Avenue W St. Paul, MN 55104
(612) 570-2087

October 18, 2016

Anthony Johnson – City Planner
Planning & Economic Development
25 W. 4th St., Suite 1400
Saint Paul, MN 55102

Mr. Johnson:

On behalf of *African American COMFOARTS, LLC*, please use this letter as demonstration of support for the LEX's application to change its existing 'non-conforming use' which will enable them to operate a restaurant at 976 Concordia Avenue, St Paul, MN 55104. It is our belief that a restaurant, to be operated in that historic building and by members of the Rondo community, will contribute immeasurably to the continued growth and economic development of the Summit-University geography.

We will take pride and pleasure in knowing our support will assist in the decision to approve the change of use application that will ultimately allow The LEX to provide residents of the Rondo community with an additional food and beverage outlet they can look forward to patronizing.

Thank you in advance for your consideration.

Sincerely,



Marvin M. Scroggins, CEO



October 18, 2016

Anthony Johnson – City Planner
Planning & Economic Development
25 W. 4th St., Suite 1400
Saint Paul, MN 55102

To whom it may concern:

On behalf of *Aurora St Anthony Neighborhood Development Corporation (ASANDC)*, please accept this letter as demonstration of our support for the LEX's application to change its existing 'non-conforming use' to become a *restaurant establishment* located at 976 Concordia Avenue, St Paul, MN 55104. It is our belief, a restaurant of this magnitude, this historic building that will both be operated and ran by members of the Rondo community, will significantly contribute to the continued growth and economic development of not only the Summit-University area but the surrounding areas as well.

We take great pride and pleasure in knowing our support will assist in the decision to approve the 'change of use' application, that will ultimately allow The LEX to provide residents of the Rondo community and abroad with an additional food and beverage outlet they can look forward to patronizing. If you find you need more information, please contact me at 651/288-9320 or by email at Nieeta@aurorastanthon.org

Thank you in advance for your consideration.

Sincerely,

Nieeta Presley

Printed Name

Title: Executive Director Aurora St Anthony Neighborhood Development Corporation (ASANDC)

Signature

October 18, 2016

Date

October 18, 2016

Anthony Johnson – City Planner
Planning & Economic Development
25 W. 4th St., Suite 1400
Saint Paul, MN 55102

To whom it may concern:

On behalf of *Nieeta Presley*, please accept this letter as demonstration of my support for the LEX's application to change its existing 'non-conforming use' to become a *restaurant establishment* located at 976 Concordia Avenue, St Paul, MN 55104. I see this new use as a great re-purpose of a building that holds fond memories for me as I grew up in the Historic Rondo community. This building, as a I grew into womanhood is where I learned leadership roles, I held my wedding reception at 976 Concordia, and had several birthday parties for my own kids as they grew.

Much was lost to my community with the development of I94 and putting this building back in use as a restaurant will have a far greater purpose than I think even before. What a special contribution to the legacy and history of the Rondo Community, its current and former residents if this historic building remains open. Most scared is the fact that it will be both owned and operated by members of the Rondo community. With this new purpose, this space will significantly contribute to the continued growth and economic development of not only the Summit-University area but the surrounding areas as well.

It is my hope that the City of Paul will consider my letter in making the decision to approve the 'change of use' application, for the owners of The LEX. If you find you need more information, please contact me at 651/283-2380 or by email at Nieeta@gmail.com

Thanking you in advance for your consideration in this matter.

Sincerely,

Nieeta Presley

Printed Name

Signature

October 18, 2016

Date

Rondo Avenue,

1360 University Ave. – PO Box 140 | St. Paul, MN 55104



Incorporated

Phone: 651.315.7676 | www.RondoAvenueInc.org

October 14, 2016

Anthony Johnson – City Planner
Planning & Economic Development
25 W. 4th St., Suite 1400
Saint Paul, MN 55102

To whom it may concern:

On behalf of Rondo Avenue, Inc., please use this letter as demonstration of support for the LEX's application to change its existing 'non-conforming use' to become a *restaurant establishment* located at 976 Concordia Avenue, St Paul, MN 55104. It is our belief a restaurant of this magnitude, to be operated in a historic building and by members of the Rondo community, will significantly contribute to the continued growth and economic development of the Summit-University geography.

We would take great pride and pleasure in knowing our support will assist with the decision to approve the 'change of use' application, that will ultimately allow The LEX to provide residents of the Rondo community and abroad with an additional food and beverage outlet they can look forward to patronizing.

Thank you in advance for your consideration.

Sincerely,

A handwritten signature in black ink that reads "Ronald C. Buford". The signature is written in a cursive style.

Ronald Charles Buford
President – Rondo Avenue, Inc.

Date: 10/14/2016

Rondo Avenue Inc. (RAI) is a non-profit community organization that has sponsored the annual Rondo Days Festival and other activities for the past 33 years. RAI's goal is to accurately present the history of the Rondo community and bring it forward to new generations.

I Robert [Signature] support the Lex's application for a change in non-conforming use to become a restaurant. I would like to support this business venture. I support the Lex as a minority owned business at this Historical Site in the Rondo Community.

Address 1000 Concordia Ave - Saint Paul MN

Phone 612-665-3831

I BRIAN LAPHAM support the Lex's application for a change in non-conforming use to become a restaurant. I would like to support this business venture. I support the Lex as a minority owned business at this Historical Site in the Rondo Community.

Address 977 CARROLL AVE

Phone 952.334.9608

I Dustin Thelen support the Lex's application for a change in non-conforming use to become a restaurant. I would like to support this business venture. I support the Lex as a minority owned business at this Historical Site in the Rondo Community.

Address 234 Victoria St. N

Phone 763 7724516

I Kevin Waebke support the Lex's application for a change in non-conforming use to become a restaurant. I would like to support this business venture. I support the Lex as a minority owned business at this Historical Site in the Rondo Community.

Address 309 Chatsworth St. N

Phone 612-807-7106

I Bobby E. Jefferson support the Lex's application for a change in non-conforming use to become a restaurant. I would like to support this business venture. I support the Lex as a minority owned business at this Historical Site in the Rondo Community.

Address 325 Chatsworth St. N

Phone 651-778-2496

Cynthia Peyton support the Lex's application for a change in non-conforming use to become a restaurant. I would like to support this business venture. I support the Lex as a minority owned business at this Historical Site in the Rondo Community.

Address 1005 Carroll Ave,

Phone _____

I Aliyah DeJonge support the Lex's application for a change in non-conforming use to become a restaurant. I would like to support this business venture. I support the Lex as a minority owned business at this Historical Site in the Rondo Community.

Address 1000 CONCORDIA AVENUE

Phone 612-867-6055

I Pedro Garcia support the Lex's application for a change in non-conforming use to become a restaurant. I would like to support this business venture. I support the Lex as a minority owned business at this Historical Site in the Rondo Community.

Address 764 Concordia ave SE Paul MN

Phone 651 707 6493



1. Basement Plan
 No. 101 Scale: 1/8" = 1'-0"

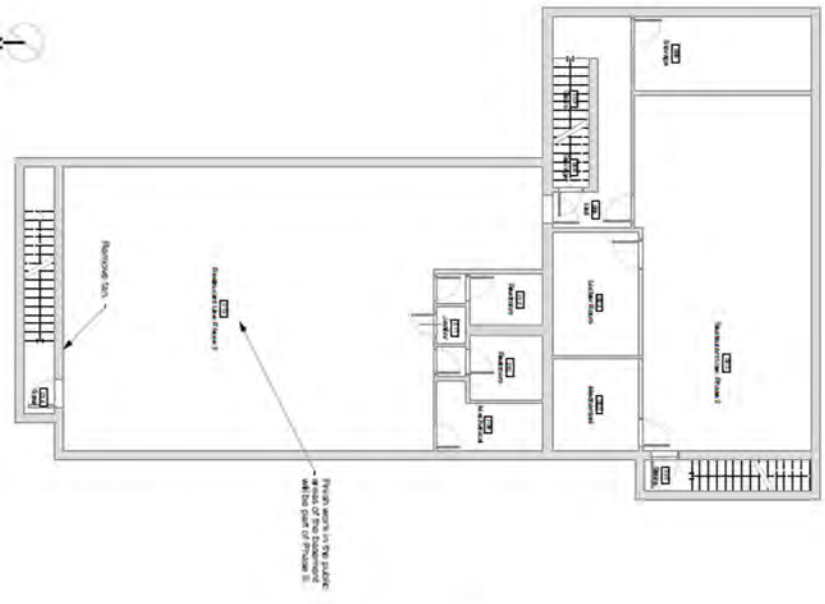

2. First Floor Plan
 No. 101 Scale: 1/8" = 1'-0"

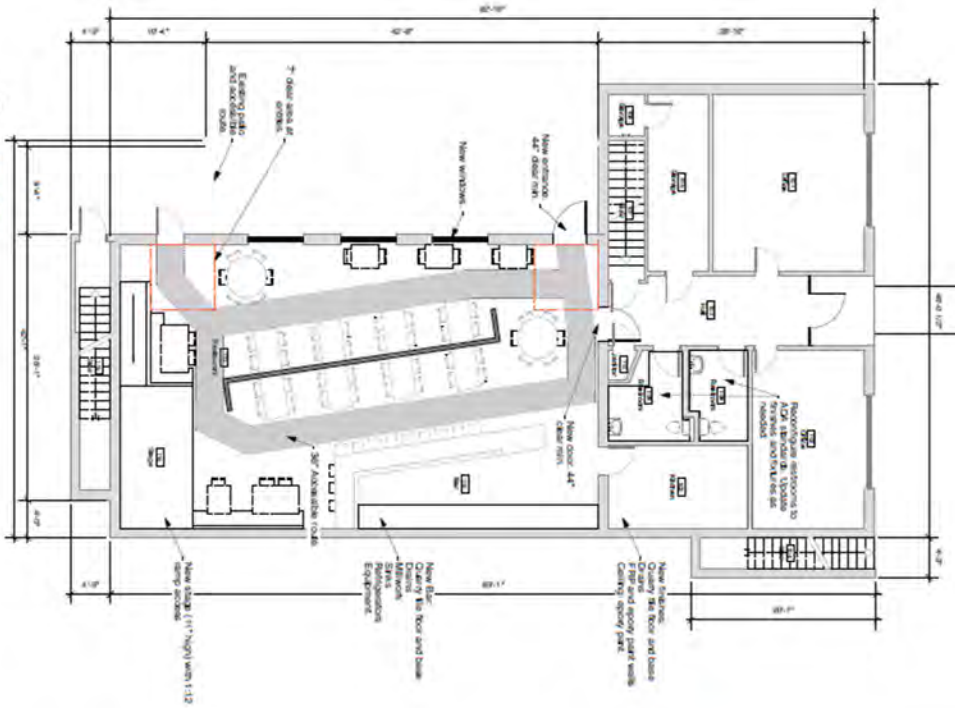

Taste of Rondo
 976 Concordia Avenue
 Saint Paul, Minnesota 55104

LUNNING
WENDE
 ARCHITECTS
 & PLANNERS
 Lunning Wendel Architects, Inc.
 2000 Hennepin Avenue
 Minneapolis, MN 55402
 Phone: 612.870.1935

DATE	REVISION

NOT FOR CONSTRUCTION

Taste of Rondo

PROJECT	Taste of Rondo
NO.	AS-101
DATE	2017.06
SCALE	AS SHOWN
DRAWN BY	[Signature]
CHECKED BY	[Signature]
DATE	2017.06
SCALE	AS SHOWN

AS-101

Scope of Work

Taste of Rondo

976 Concordia Avenue

Phase One for Restaurant with Beer and Wine License

Outline of Preliminary Scope of Work

Prepared by Lunning Wende Associates

Division One – General Requirements

01100 – Summary of Work

The phase one renovation of 976 Concordia Avenue will be limited to First Floor with the exception of code-related life safety, fire protection, mechanical and electrical services in the Basement. The scope of the phase one work focuses on Rooms 102, 103, 108, 109, 110, 112, and 114 to serve as a restaurant and bar serving beer and wine only. These rooms will serve the public or support the phase one restaurant use. The remainder of the building will not be used by the public at this time. Refer to attached drawing: As-101 (Taste of Rondo Phase 1 20171010.pdf).

01300 – Administrative Requirements

The contractor and the owner will enter into a standard form of agreement for the project. This agreement shall include and reference the drawings and specifications.

The contractor shall secure all permits required for the work.

The work shall be performed in accordance with all applicable codes.

The contractor shall provide the owner with certificates of insurance related to the work.

01410 – Quality Assurance & Control

The contractor and subcontractors shall be licensed by the governing authorities and have demonstrated qualifications to perform the work.

Workers shall be trained and experienced in the elements of the work for which they are directly responsible.

Product or material substitutions shall be allowed only with prior approval of the owner and/or architect.

Follow manufacturers' installation instructions.

01510 – Temporary Facilities & Controls

TASTE OF RONDO RESTAURANT

The contractor may use the building utilities and services in the performance of the work. Replace filters at the completion of the work and return building fixtures and equipment to their pre-construction condition.

Protect the building and life safety during the performance of the work.

01710 – Execution & Close-out Requirements

The contractor shall be paid for the work completed, materials on site, and equipment & furnishings stored off-site, if documented.

Applications for Payment will be promptly reviewed by the architect and owner.

Perform final clean of all surfaces, equipment and furnishings prior to substantial completion.

Notify the owner and architect prior to substantial completion to schedule a final review of the work and make corrections to deficiencies identified in the final review.

Provide the owner or his representatives with training and/or instruction manuals for all equipment requiring service or operation following substantial completion

Division Two – Site Construction

02220 – Selective Interior Demolition

Remove exhaust fan between Rooms 013 & 014, deactivate electrical power to fan.

Remove partitions in toilet rooms to improve accessibility.

Remove portion of partition between Rooms 109 & 110 to improve accessibility.

Remove portion of masonry partition at jamb between Rooms 102 & 112 to provide egress width at door.

Remove door and frame between Room 102 and exterior.

Remove wall and floor finishes in Room 103.

Remove electrical service to the panel in Room 103.

02230 – Selective Exterior Demolition

Cut openings and demolition concrete masonry walls for new doors and windows, shown in the Drawings. Shore, as required, to stabilize the building and to assure life safety.

Remove site concrete to accommodate an accessible route into the building.

02500 – Utility Services

Verify utilities are adequate for proposed occupancy.

Specifically, determine required water service is adequate for new fire protection system. Provide new water service to building, if required to meet this increased capacity.

02900 – Planting

Seed or sod lawn areas disturbed by the work.

Division Three – Concrete

03050 – Basic Concrete Materials and Methods

All work shall be in accordance with applicable codes and industry standards.

03300 - Cast-in-Place Concrete

Prepare existing concrete slab and pour 12-inch +/- ramp to provide accessible threshold condition at door at southwest corner of the building.

Division Four – Masonry

04050 – Basic Masonry Materials and Methods

All work shall be in accordance with applicable codes and industry standards.

04200 – Masonry Units

Match existing masonry in size color, and texture to the greatest extent possible. Salvage and re-use existing brick, if feasible.

04800 – Masonry Assemblies

Repair hole in wall between Rooms 013 & 014 with concrete masonry to match surrounds.

Repair jamb, head and sill of masonry openings cut for windows and doors. Match surrounds and details of existing masonry openings in the building to the extent possible.

Division Five – Metals

05050 – Basic Metal Materials and Methods

All work shall be in accordance with applicable codes and industry standards.

05100 – Structural Metal Framing

Provide and set steel lintels at heads of new masonry openings to receive windows and doors.

Division Six – Wood & Plastic

06050 – Basic Materials and Methods

All work shall be in accordance with applicable codes and industry standards.

06100 – Rough Carpentry

Build new gypsum board systems wall between Rooms 109 and 110.

Build gypsum board systems half wall in Room 112.

Build stage and ramp in Room 112.

Install blocking as required.

06200 – Finish Carpentry

Install serving and back bar cabinetry and counters.

Install paneling for half wall in Room 112.

Install trim, shelving, and other attachments or accessories.

Install decorative wood ceiling in Room 112.

06400 – Architectural Woodwork

Provide serving and back bar cabinetry and counters. Allowance: \$175 per lineal foot.

Provide paneling for half wall in Room 112. Allowance: \$20 per lineal foot.

Provide decorative wood ceiling in Room 112. Allowance: \$15 per square foot.

Division Seven – Thermal & Moisture Protection

07050 – Basic Materials and Methods

All work shall be in accordance with applicable codes and industry standards.

07500 – Membrane Roofing

Inspect existing roofing and repair as needed.

07600 – Flexible Flashing

Install head flashing at doors and windows.

Install sill dams at windows

07800 – Fire and Smoke Protection

Install fire resistant caulking at penetrations in fire-rated wall and floor systems.

07900 – Joint Sealers

Install joint sealants, continuously, as a thermal barrier and/or as a transition between different materials.

Division Eight – Doors & Windows

08050 – Basic Materials and Methods

All work shall be in accordance with applicable codes and industry standards.

08100 – Metal Doors and Frames

Install hollow metal frames at new door and/or window openings between two interior spaces.

08200 – Wood and Plastic Doors

Install wood doors, where shown in new openings between to interior spaces. Wood species used in doors shall match existing doors.

08400 – Entrances and Storefronts

Install three (3) thermally-broken aluminum frames and full-lite doors at new exterior door openings in Rooms 102 and 112.

08500 – Windows

Install three (3) 5-foot high by 6-foot wide SST-!! Bi-fold System windows by Crown Incorporated or equal in west wall of Room 112. Basis of Design: **Crown Incorporated** 135 McLeod Avenue/South Plato, Minnesota 55370/ Phone: 320-238-2616/ info@crowndoors.com

08700 – Hardware

Install lever latchsets on all passage doors.

Install panic hardware on doors in the path of egress.

Install level locksets on toilet room doors.

Install hinges, closers, kickplates, gasketing, weatherstripping, on doors, as required, to meet code and/or functional requirements.

08800 – Glazing

Glazing in openings between two interior spaces shall be clear, impact resistant, ¼-inch glass.

Glazing in exterior walls shall be tinted, double-glazed, thermal-sealed, ½-inch argon gas-filled.

Division Nine – Finishes

09200 – Gypsum Board Systems

Provide gypsum wallboard and cold-formed steel stud systems.

09300 – Tile

Install quarry tile floor and 6-inch high base in Rooms 103 and 114.

09400 – Terrazzo

Repair and clean existing terrazzo flooring, as required.

09700 – Wall Finishes

Install Marlite Symmetrix with Sani-Coat Fiberglas Reinforced Panels in Kitchen 103, 6-foot wainscot on all walls.

Absorbing Panels (1.125" x 24" x 48" direct applied to precast plank ceilings in Room 112.

09900 – Paints and Coatings

Paint ceilings in Rooms 102, 108, 109, 110, 112, and 114: acrylic latex, flat, two-coats

Paint walls in Rooms 102, 108, 109, 110, 112, and 114

Paint ceiling Room 103: epoxy, semi-gloss, two-coats.

Paint walls about wainscot in Room: 103: epoxy, semi-gloss, two-coats.

Coat exposed wood on serving and back bar, panel, dropped ceiling, etc. with penetrating stain and two coats of satin, water-based polyurethane.

All paint and coating products shall be low VOC.

All paint and coating products by Sherwin Williams or approved equal.

Division Ten – Specialties

10520 – Fire Protection Specialties

Fire extinguishers: Two (2) Larson Dry Chemical.

10800 – Toilet, Bath, and Laundry Accessories

Install accessibility grab bars, thermal pipe wrap on exposed pipes, soap dispensers, hand towel dispensers in Rooms 108 and 109.

Division Eleven – Equipment

11400 – Food Service Equipment

See attached equipment lists:

Taste of Rondo Equip+Furnishing-08122017

Taste_of_Rondo_Equipment-09062017

Provide and install in Room 103:

TASTE OF RONDO RESTAURANT

Microwave Convection/Impingement Oven – TurboChef C3 (Item 2)

Ventless Enclosed Fryer, Electric – MTI Autofry MTI-40C3 (Item 3)

Safety System Moveable Gas Connector: Dormont Manufacturing Model No. 1675BPQR48, 2 each (Item 15)

Hand Sink: Advance Tabco Model No. 7-PS-60-2X (Item 16)

Work Table, Stainless Steel Top: Advance Tabco Model No. KSS-306, 2 each (Item 17)

Reach-in Refrigerator: Delfield Model No. GCR2P-S (Item 19)

Three Compartment Stainless Steel Sink

Provide and install in Room 114:

Ice Bin: Perlick Corporation Model No. TS30IC10, 2 each (Item 4)

Under Bar Glasswasher: Perlick Corporation Model No. PKHT24 (Item 7)

Back Bar Cabinet, Refrigerated: Perlick Corporation Model No. BBSN72 (Item 8)

Draft Beer System, Remote: Custom Model No. BEER SYSTEM (Item 9)

Hand Sink: Advance Tabco Model No. 7-PS-60-2X (Item 16)

Provide and Install in Storage:

Keg Storage Rack: New Age Model No. 1288, 2 each (Item 11)

Dunnage Rack: New Age Model No. 2052, 2 each. (Item 12)

Dunnage Rack: New Age Model No. 2054 (Item 13)

Reach-in Freezer: Delfield Model No. GCF2P-S (Item 20)

Wire Shelving: Centaur Model No. C2448K, 4 each (Item 21)

Verify food service equipment with Charles Carter – 651.403.0525.

Division Twelve – Furnishing

12500 – Furniture

Provide and assemble: -17chairs, 14-stools, 4-two-person tables, 3-four person tables, 1-six person round table,2-four person hi-top tables, 12 lineal feet of banquette seating.

Product References:

Stools: MTS Seating Model No. 948-30 GR9 (Item 25)

Chairs: MTS Seating Model No. 948 GR9 (Item 26)

Table Tops & Bases: MTS Seating Model No. 380-24X30-N (Item 27), MTS Seating Model No. 380-30X60-N (Item 28), MTS Seating Model No. 380-60R-N (Item 29)

Division Thirteen – Special Construction

13850 – Detection and Alarm

Provide fire and burglary alarm systems with remote notification.

Division Fourteen – Conveyance Systems

Not Used

Division Fifteen - Mechanical

15050 – Basic Mechanical Materials and Methods

All work shall be in accordance with applicable codes and industry standards.

15100 – Building Services Piping

Install gas piping for equipment specified in 11400. Verify existing gas piping and connections meets code requirements and correct deficiencies.

Install water supply piping for equipment specified in 11400. Concealed piping maybe PEX; exposed piping to be copper.

Install waste piping for equipment specified in 11400.

15300 – Fire Protection Piping

Provide and install Automatic Sprinkler System throughout the building, in accordance with Chapter 9 of IBC-2012.

15400 – Plumbing Fixtures and Equipment

Referenced in 11400 and specified in the attached equipment list.

Provide and install floor drains in Rooms 103 and 114.

15700 – Heating, Ventilating, and Air Conditioning Equipment

See comments in 15950. Verify function of existing equipment, correct deficiencies and increase capacity to meet project requirements if necessary. Consider the additional ventilation requirements of equipment specified in 11400.

15800 – Air Distribution

Provide and install aluminum spiral duct supply and return piping to serve the functional requirements of each space. Install ductwork in an orderly pattern serving functional and aesthetic needs.

15900 – HVAC Instrumentation and Controls

Upgrade instrumentation and controls to improve energy efficiency of the systems.

15950 – Testing, Adjusting, and Balancing

City of Saint Paul Mechanical Inspector's Comments:

While mechanical systems appear to meet the basic needs of the use, two issues need to be addressed:

A fan that exhausts from the lower level bar into an egress stairway needs to be removed to maintain the rated enclosure of the stairway.

No permit is on file for two rooftop units with economizers. Therefore, the owner needs to verify the units provide sufficient ventilation and make-up air for the proposed equipment and occupancy. The system needs to be balanced and tested to determine that code requirements are met. If the system does not meet code requirements for ventilation, it will need to be modified.

There is also no permit for the gas piping serving the rooftop units. The gas connection needs to be inspected to determine proper installation.

Division Sixteen – Electrical

16050 – Basic Electrical Materials and Methods

All work shall be in accordance with applicable codes and industry standards.

16100 – Wiring Methods

All wiring shall be in rigid conduits installed in an orderly pattern for minimal visual impact.

16200 – Electrical Power

Verify electric service is adequate for project requirements; upgrade service if necessary.

16300 – Electrical Distribution

Install electrical distribution for functional requirements, fire/smoke/carbon monoxide detection, fire/burglary alarm system, and equipment specified in 11130 and 11400

16400 – Low-Voltage Distribution

Install wiring for equipment specified in 11400, wireless hub and basic business services, as required.

Install fire and burglary alarm systems with remote notification specified in 13850.

16500 – Lighting

General Interior Illumination: Provide and install adequate illumination to serve the functional requirements of each space in the building.

Exterior Illumination: Provide and install adequate illumination for life safety, ease of access, and building identification.

Exterior Signage: Provide electrical service to sign provided and installed by others.

All lighting fixtures shall be selected for energy efficiency. Use LED lamps wherever practical.

Special Lighting in Room 112:

Entry – chandelier: 1 fixture. Product Reference: Possini All Red Giclee Pendant Chandelier 16" wide x 5' 1/2" high. Style # G9447-H1193. Fixture Allowance: \$250.

Dining – pendant for table illumination: 4 fixtures. Product Reference: El Cajon 6-1/4" Wide Brown Modern LED Mini Pendant Style # 9J296. Fixture Allowance: \$300.

Serving Bar – pendant for bar illumination: 5 fixtures. Product Reference: Possini Euro Brevard 19" Wide Black Pendant Light Style # 15D15. Fixture Allowance: \$750.

Back Bar: Product Reference: 60 lineal feet LED color changing strip lights. Fixture Allowance: \$250.

Stage: 8 fixtures. Product Reference: Spotlight Cylinder LED Track Lighting (black). Fixture Allowance: \$600.

 **DEPARTMENT OF HEALTH** Food and Beverage Report on Plan

Plans and specifications on Rem Food: Taste of Rondo, Project No. 190333

Location: 976 Concordia Avenue, St Paul, MN 55104, Ramsey County

Date Approved: November 16, 2018 Date Received: November 15, 2018

Submitted by: Taste of Rondo, 976 Concordia Avenue, St Paul, MN 55104, (612) 268-8441

Ownership:

Thank you for submitting plans to the Minnesota Department of Health (MDH). The plans appear to be in general compliance with the standards of this department and have been approved. You are responsible for compliance with all aspects of the Minnesota Food Code. This code is available at <http://www.health.state.mn.us/divs/eh/food/code/index.html>. Please pay special attention to the bolded items.

Scope of Project: This is a remodeling project of an existing category-three food service establishment. The proposed menu includes omelet (sausage, bacon, cheese), pancakes, fried green tomatoes, chicken wings, coco shrimp, catfish basket, wontons, smothered Cajun fries, stuffed portabella mushrooms, biscuits, crab cakes, beef brisket sliders, gumbo, crab bisque, white chicken chili, grilled chicken salad, jambalaya, fried chicken, shrimp & grits, pot roast and ribs. The submitted menu does not include any specialized food processes but should be considered a high-risk establishment. No changes will be made to the existing water & sewer systems.

Contact Melissa Ramos at 651-201-4495 to obtain a license application and to schedule all pre-operational inspections. All license fees must be paid prior to scheduling all pre-operational inspections.

No food is permitted in the establishment until approval from the Health Authority is given.

The foodservice facility may not operate during remodeling construction.

1. Equipment Standards – General Requirements:

Food and beverage equipment shall meet the applicable standards for one of the following:

- National Sanitation Foundation (NSF).
- Edison Testing Laboratories (ETL) to NSF Standards.
- Underwriters Laboratory (UL) to NSF standards.
- Canadian Standards Association (CSA) to NSF Standards.

2. Equipment shall bear the NSF or equivalent sticker and manufacturer information. Specification information from a manufacturer for the following item(s) or equipment was supplied for review: **The following pieces of new equipment meets food code standards and will be approved. An approved gas convection oven by SOUTHBEND, countertop gas charbroiler by SOUTHBEND, countertop gas griddle, 24" open burner range oven by SOUTHBEND, two gas fryers by DEAN, microwave oven by PANASONIC, heat lamp by HATCO, tea brewer by CURTIS, coffee brewer by CURTIS an espresso machine by GRINDMASTER/CECILWARE and ice bin by PERLICK submitted.**

Used NSF approved food and beverage equipment may not be changed or altered from its original condition. Used equipment indicated on the plan: **At the time of submittal, the following piece of equipment was listed as being USED. An existing two-door reach-in refrigerator.**

The Sanitarian conducting the pre-operational inspection will follow up to ensure that all equipment meets applicable standards.

All custom fabricated equipment shall meet NSF International or equivalent standards and bear a sticker indicating the equipment meets the standard. **At the time of submittal, no CUSTOM equipment was proposed.**

Food contact surfaces (tables and counters) shall be of stainless steel in compliance with NSF Standard No. 2 or equivalent. **Approved stainless steel worktables by JOHN BOOS.**

Table-mounted equipment that is not easily movable shall be sealed to the table or elevated on four (4) inch NSF legs.

Enough equipment for cooking, heating and hot holding shall be provided. Equipment should be sufficient in number and capacity to meet the needs of the establishment.

Enough equipment for cooling and cold holding shall be provided. Equipment should be sufficient in number and capacity to meet the needs of the establishment.

3. **Walk-in Cooler/Freezer/Refrigerator: An approved sandwich prep table by BEVERAGE AIRE, reach-in refrigerator by DELFIELD, two-door reach-in freezer by DELFIELD, single door reach-in unit by DELFIELD, refrigerated base refrigerator by DELFIELD, worktop freezer by DELFIELD, sandwich/salad preparation refrigerator by DELFIELD, refrigerated back bar cabinet by PERLICK, draft beer cooler by PERLICK submitted.**

Shelving inside coolers and freezers must meet NSF International or equivalent standards and shall be approved for use in a cold environment.

4. **Ventilation System: An approved 14ft 9inch mechanical exhaust ventilation system by CAPTIVE-AIRE.**

All ventilation systems shall be designed, installed and operated according to chapter 1346 of the Minnesota Mechanical and Fuel Gas Codes.

Exhaust ventilation systems shall be designed to prevent grease or condensation from draining or dripping onto food, equipment, utensils, walls, ceiling, linens and single-service articles.

All rooms shall have sufficient tempered make-up air and exhaust ventilation to keep them free of excessive steam, condensation, vapors, obnoxious or disagreeable odors, smoke and fumes.

Exposed utility service lines and pipes shall not be installed directly on the walls or floor, except:

- a. quick disconnect gas hoses approved by the American Gas Association or NSF International, and
- b. flexible cords and caps for commercial cooking equipment on casters, listed by Underwriter's Laboratory.

5. Sinks:

An approved stainless steel corner three-compartment sink with dual integral drain boards by JOHN BOOS submitted.

- Sink bowls shall be adequately sized for the largest utensil to be washed in the three-compartment sink.
- Approved racks, shelves or dish tables for storing soiled equipment and utensils and air-drying clean equipment and utensils will be provided.

An approved stainless steel two-compartment food preparation sink with dual integral drain boards will be installed.

Two approved stainless steel hand sinks by JOHN BOOS, hand sink by PERLICK submitted.

- Each handwashing sink shall be provided with hot and cold water through a mixing valve or combination faucet.
- An eyewash station may not be connected directly to a handwashing sink.

A dump sink will be provided.

A mop sink will be provided.

- The mop sink shall be provided with hot and cold running water.

- A mop hanger, broom rack or other device shall be provided for hanging wet mops.

6. Dishmachine: An approved undercounter high temperature mechanical dishwasher & glass washer by JACKSON submitted.

High temperature sanitizing warewashing machines shall have space for a minimum of three racks for air-drying utensils.

A warewashing machine that uses a chemical for sanitization shall be equipped with a device that indicates audibly or visually when additional chemical sanitizer is needed.

7. Cabinetry: An approved dish cabinet & beverage counter by JOHN BOOS. Pass-thru cocktail station by PERLICK.

Cutouts in millwork and exposed wood surfaces on cabinets and under counter tops shall be sealed to provide a smooth and easily cleanable surface.

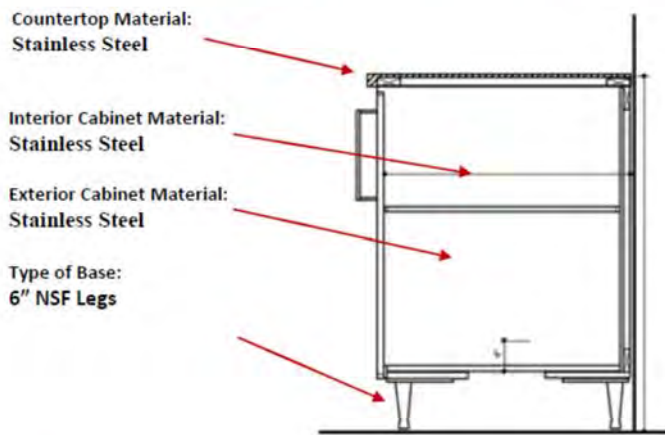

8. Storage Area:

Provide an adequate amount of storage space for supplies necessary for the operation. **An approved wall-mounted shelving by JOHN BOOS supplied.**

Shelving will be provided to maintain food items, single-service items and equipment six (6) inches above the floor. **Approved wire storage shelving by CENTAUR submitted.**

9. Physical Facility:

Floors, walls, and ceilings in areas where food is stored, prepared or washed, toilet rooms and janitorial rooms shall be smooth, non-absorbent, durable and easily cleanable.

Approved Finish Schedule

Finish Area	Walls:	Ceiling:	Floor/Integral Cove Base:
Front Kitchen:	FRP/stainless steel behind equip.	GWB Enamel	Dur-A-Flex Poly-Crete Urethane
Back Kitchen:	FRP	ACT	Epoxy resinous floor
Bar:	FRP	GWB Enamel	Resinous floor
Janitor Closet:	FRP	ACT	Resinous floor

Integral base cove shall be installed at all floor/wall junctures.

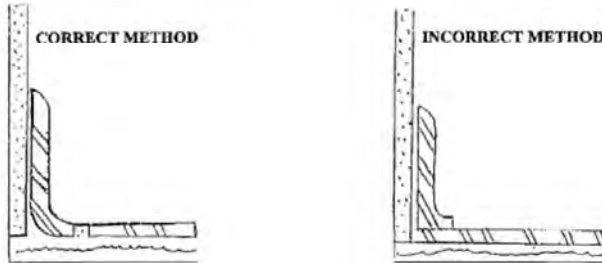

Non-slip tile or rough aggregate may not be located underneath equipment.

10. Lighting:

Install a sufficient number of shielded lighting fixtures in the dry storage areas to provide a minimum of 10 foot candles measured at 30 inches above the floor.

Customer self-service areas, food and utensil storage rooms, areas behind a bar and toilets rooms shall be provided with at least 20 foot candles of shielded light measured at 30 inches above the floor.

Food preparation areas in which food or beverages are prepared, utensils are washed shall provide a minimum of 50 foot-candles of shielded light measured 30 inches above the floor.

11. Dressing Rooms and Lockers:

Lockers or other suitable facilities shall be provided for the orderly storage of employee's clothing and other possessions.

12. Bar/Wait station:

The bar top finish will be: **NOT Supplied for review/Unknown**. The underside of a wood bar top must be properly finished.

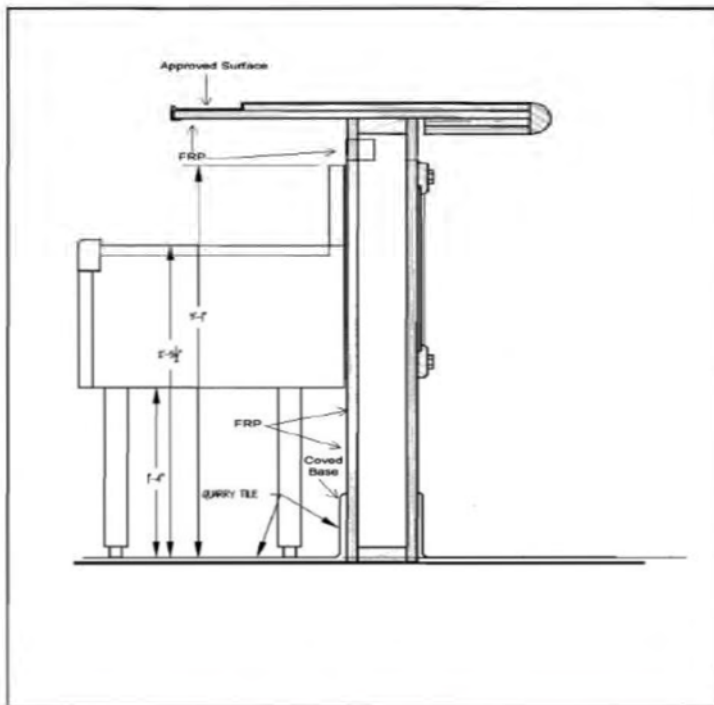

The tap tower is attached to an approved bar surface indirectly wasted to a floor drain.

The self-contained draft beer cooler must be indirectly wasted to a floor drain.

13. Plumbing: All Plumbing Plans must be inspected and approved by the City of St Paul.

A plumbing plan approval letter has not been received at this time. Provide at opening inspection evidence that the plumbing system has been inspected and approval given by

the local building official or a representative from the Department of Labor and Industry (DOLI).

All pipe chases that pass through walls shall be tightly sealed and covered with escutcheon rings.

All utility lines shall be enclosed in walls or ceilings. Any exposed utility lines must be installed at least 6" off the floor.

Indirect waste pipes shall not discharge into hand sinks, prep sinks or three-compartment sinks.

Telltale drains are required for food service sinks.

All commercial water heaters shall be of adequate capacity to meet the needs of the anticipated demand of the establishment. Water heater submitted: **The existing hot water heater can be re-used.**

14. Other Code Requirements:

All wastewater shall be treated at a municipal system or an approved septic system as defined in Minnesota Rules 7080.

Contact MN Electrical Licensing & Inspection at 651-284-5026 or visit their website at <http://www.dli.mn.gov/business/electrical-contractors> for information on electrical requirements and the name of the electrical inspector in your area.

Sincerely,



V. Calvin Mathews II
Minnesota Department of Health
Food, Pools, and Lodging Services Section
625 Robert Street North
St. Paul, MN 55155

CITY OF SAINT PAUL, MINNESOTA
(Nonconforming Use Permit - Change)

ZONING FILE NO: 16-091-649
APPLICANT: Charles Carter
PURPOSE: Change of nonconforming use from private club to restaurant, private club, and meeting space.
LOCATION: 976 Concordia Ave.
LEGAL DESCRIPTION: Parcel Identification Number (PIN) 35.29.23.34.0005, legally described as Donnelly's Addition to St Paul Lots 7 & Lot 8 Block 2
ZONING COMMITTEE ACTION: Recommended approval with conditions on November 10, 2016
PLANNING COMMISSION ACTION: Approved with conditions on November 18, 2016
CONDITIONS OF THIS PERMIT: 1. Food and beverages shall be served no later than 12 midnight. 2. Any interior or exterior changes to the site associated with the change of use to a restaurant shall receive permit and /or site plan approval from the Department of Safety and Inspections. 3. The restaurant shall comply with all applicable laws and licensing requirements.
APPROVED BY: Barbara Wencil, Commission Chairperson

I, the undersigned Secretary to the Zoning Committee of the Planning Commission for City of Saint Paul, Minnesota, do hereby certify that I have compared the foregoing copy with the original record in my office; and find the same to be a true and correct copy of said original and of the whole thereof, as based on minutes of the Saint Paul Planning Commission meeting held on November 18, 2016, and on record in the Saint Paul Planning Office, 25 West Fourth Street, Saint Paul, Minnesota.

This permit will expire two years from the date of approval if the use herein permitted is not established, subject to administrative extension not to exceed one year (Sec. 61.105).

The decision to grant this permit by the Planning Commission is an administrative action subject to appeal to the City Council. Anyone affected by this action may appeal this decision by filing the appropriate application and fee at the Zoning Office, 1400 City Hall Annex, 25 West Fourth Street. **Any such appeal must be filed within 10 calendar days of the date of the Planning Commission's decision.**

Violation of the conditions of this permit may result in its revocation.



Cherie Englund
Secretary to the Saint Paul
Zoning Committee

Copies to:
Applicant
File No. 16-091-649
District Council 8

Mailed: November 18, 2016



Taste of Rondo



Restaurant Buildout for:
Taste of Rondo
976 Concordia Avenue
Saint Paul, Minnesota 55104

PROJECT LOCATION



PROJECT TEAM

OWNER	ARCHITECT	GENERAL CONTRACTOR
Taste of Rondo 976 Concordia Avenue Saint Paul, MN 55104	Landing Point Associates, Inc. 276 Park Street East, Suite 400 Saint Paul, MN 55103	Larkin Group, LLC 6401 East Avenue Dr. Minneapolis, MN 55427
Client: Clayton PH: 651.465.0533	CONTACT: Bob Lander PH: 651.221.0975 Email: bob@landingpoint.com	CONTACT: Matt PH: 612.281.8024 Email:

PROJECT GENERAL NOTES

- The Project Shall Be Constructed As Approved By The Owner To Maintain Operations Of The Facility.
- Contractor Shall Obtain All Building Permits Required For The Project.
- Contractor Shall Comply With The Owner Rules And Regulations Regarding Construction Hours Of Operation, Demolition, Placement And Eject Of Construction Loads And Other Construction Items.
- Contractor Shall Be Completely Responsible For Construction Means, Methods, Techniques, Sequence And Protection, Safety, Procedures And Programs In Connection With The Project. This Requirement Shall Apply Continuously And Not Be Limited To Normal Working Hours. Contractor Shall Maintain A Safe Pedestrian Walkway Around The Perimeter Of The Work Area Throughout The Duration Of Construction.

PROJECT DESCRIPTION

The Work consists the remodeling of 976 Concordia Avenue, the renovation of the 1,298 square feet of the First Floor (Street Level) to serve as the Taste of Rondo Restaurant and Bar, as described in the Contract Documents. The Work will include, but is not limited to: demolition of masonry and gypsum wallboard partitions, ceilings, and related mechanical and electrical systems; re-configuration of exterior masonry walls at openings; gypsum wallboard partitions, doors, frames, hardware, suspended ceilings, specialties and finishes; insulation systems including planting, heating, ventilating and air conditioning; and electrical systems including power, lighting and special systems.

DRAWING INDEX

- G100 TITLE SHEET AND CODE DATA
- G101 HISTORIC PHOTOGRAPHS
- G200 SITE PLAN
- G300 EXISTING CONDITIONS AND DEMOLITION NOTES
- G400 FLOOR PLANS
- G500 CEILING PLANS
- G600 FRAMING PLANS AND SCHEDULES
- G700 CASING AND EQUIPMENT PLANS
- G800 EXTERIOR BUILDING ELEVATIONS AND SECTIONS
- G900 INTERIOR FINISHES
- G1000 INTERIOR ELEVATIONS
- G1100 INTERIOR ELEVATIONS AT COLLECTOR ROOMS
- G1200 DETAILS AND OPENINGS
- G1300 FOODSERVICE EQUIPMENT PLAN

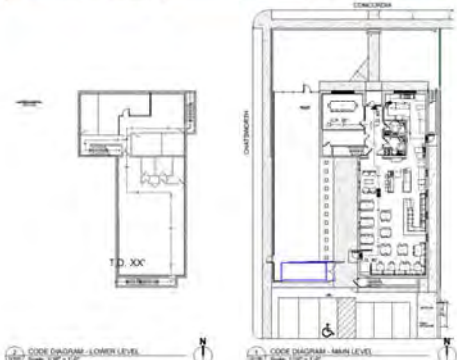

LEGEND

- 1 HOUR MASONRY
- 2 HOUR FIRE WALL
- 2 HOUR BUILDING DETENTION
- CONCRETE
- TRAVEL SURFACE
- EXIST. DRIVE
- 1\"/>

CODE REVIEW

DESCRIPTION	REQUIREMENT	REMARKS
CONSTRUCTION TIME	6.4	
CONSTRUCTION METHOD	6.4	
ALL PARTS & MATERIALS	1.10	1.10
ACTUAL WEIGHT	1.10	1.10
ACTUAL AREA PER FOOTING	1.10	1.10
REINFORCEMENT	1.10	1.10

PLUMBING FIXTURES

PLUMBING FIXTURES	WC	WC	WC	WC	WC	WC
WALL	10	10	10	10	10	10
FLOOR	10	10	10	10	10	10
CEILING	10	10	10	10	10	10



NOT FOR CONSTRUCTION

G100

Rondo

Restaurant Dailabout for:
Taste of Rondo
 970 Concordia Avenue
 Saint Paul, Minnesota 55104

NOT FOR CONSTRUCTION

HISTORIC RONDO IMAGES

G101

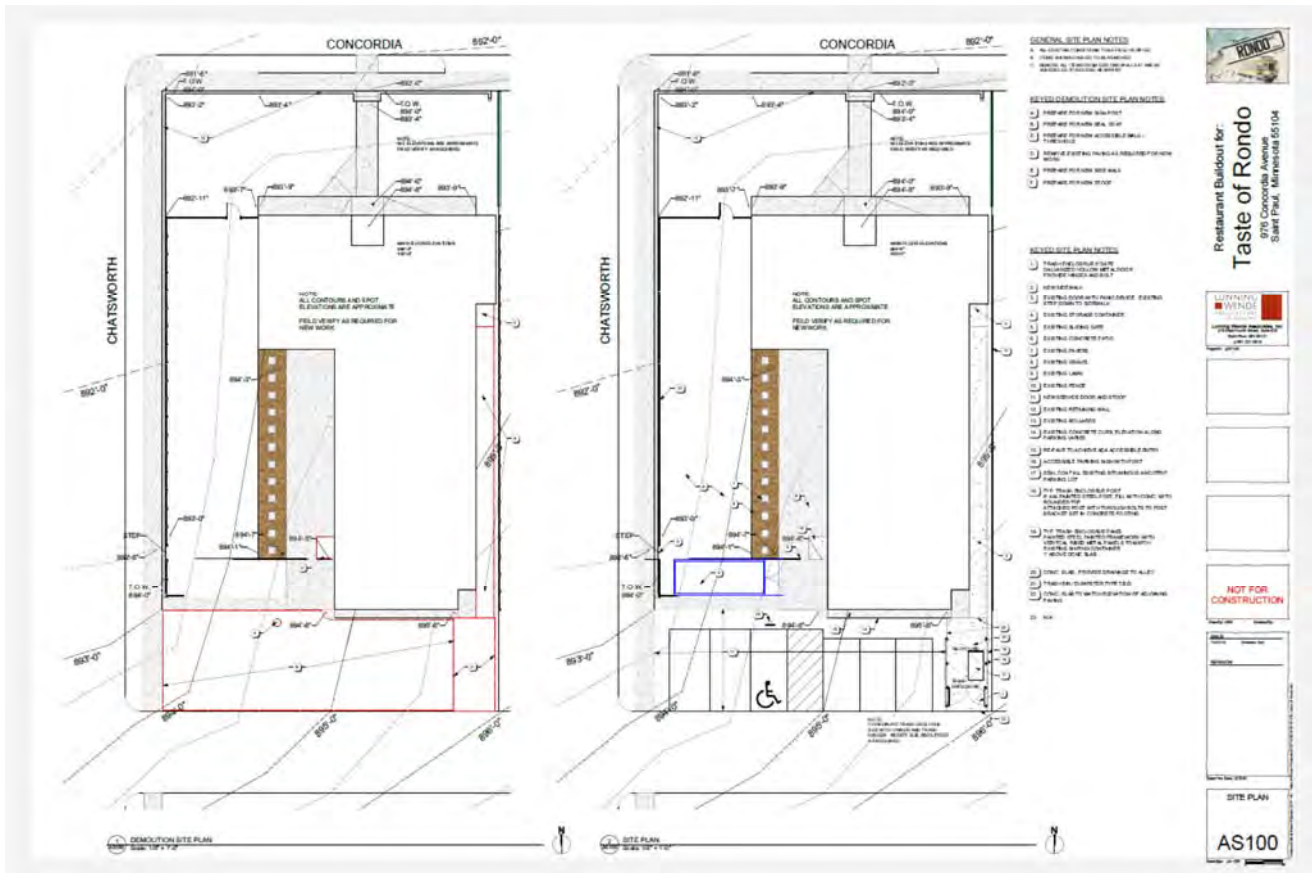

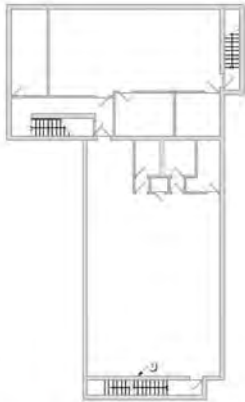

EXISTING MAIN LOWER LEVEL

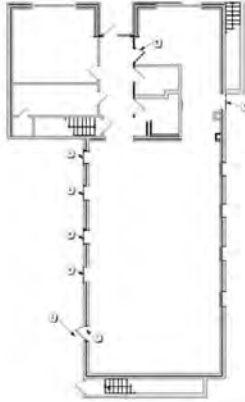

EXISTING MAIN FIRST FLOOR

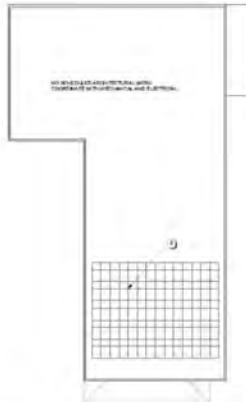

EXISTING MAIN ROOF

- GENERAL REMEDIATION NOTES**
1. REMOVE ALL EXISTING MATERIALS AND DEMOLITION AS SHOWN.
 2. DEMOLITION SHALL BE ACCORDING TO ALL APPLICABLE REGULATIONS AND PERMITS.
 3. DEMOLITION SHALL BE ACCORDING TO ALL APPLICABLE REGULATIONS AND PERMITS.
 4. DEMOLITION SHALL BE ACCORDING TO ALL APPLICABLE REGULATIONS AND PERMITS.

- EXISTING CONDITIONS AND REMEDIATION NOTES**
1. REMOVE ALL EXISTING MATERIALS AND DEMOLITION AS SHOWN.
 2. DEMOLITION SHALL BE ACCORDING TO ALL APPLICABLE REGULATIONS AND PERMITS.
 3. DEMOLITION SHALL BE ACCORDING TO ALL APPLICABLE REGULATIONS AND PERMITS.
 4. DEMOLITION SHALL BE ACCORDING TO ALL APPLICABLE REGULATIONS AND PERMITS.
 5. DEMOLITION SHALL BE ACCORDING TO ALL APPLICABLE REGULATIONS AND PERMITS.
 6. DEMOLITION SHALL BE ACCORDING TO ALL APPLICABLE REGULATIONS AND PERMITS.



Restaurant Ballroom for
Taste of Rondo
 970 Concordia Avenue
 Saint Paul, Minnesota 55104



NOT FOR CONSTRUCTION

DATE: _____

SCALE: _____

PROJECT: _____

DATE: _____

EXISTING CONDITIONS AND REMEDIATION NOTES

AD101

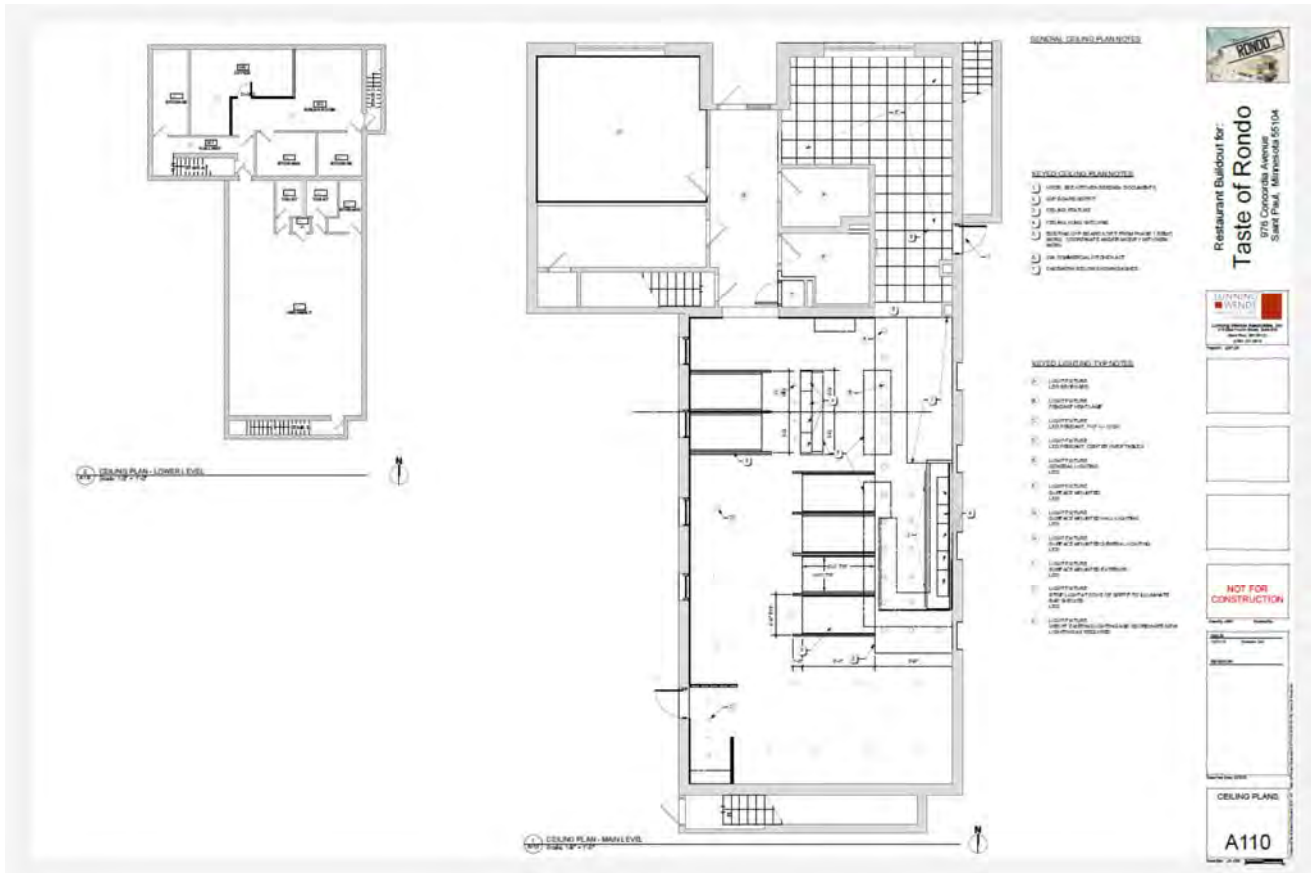
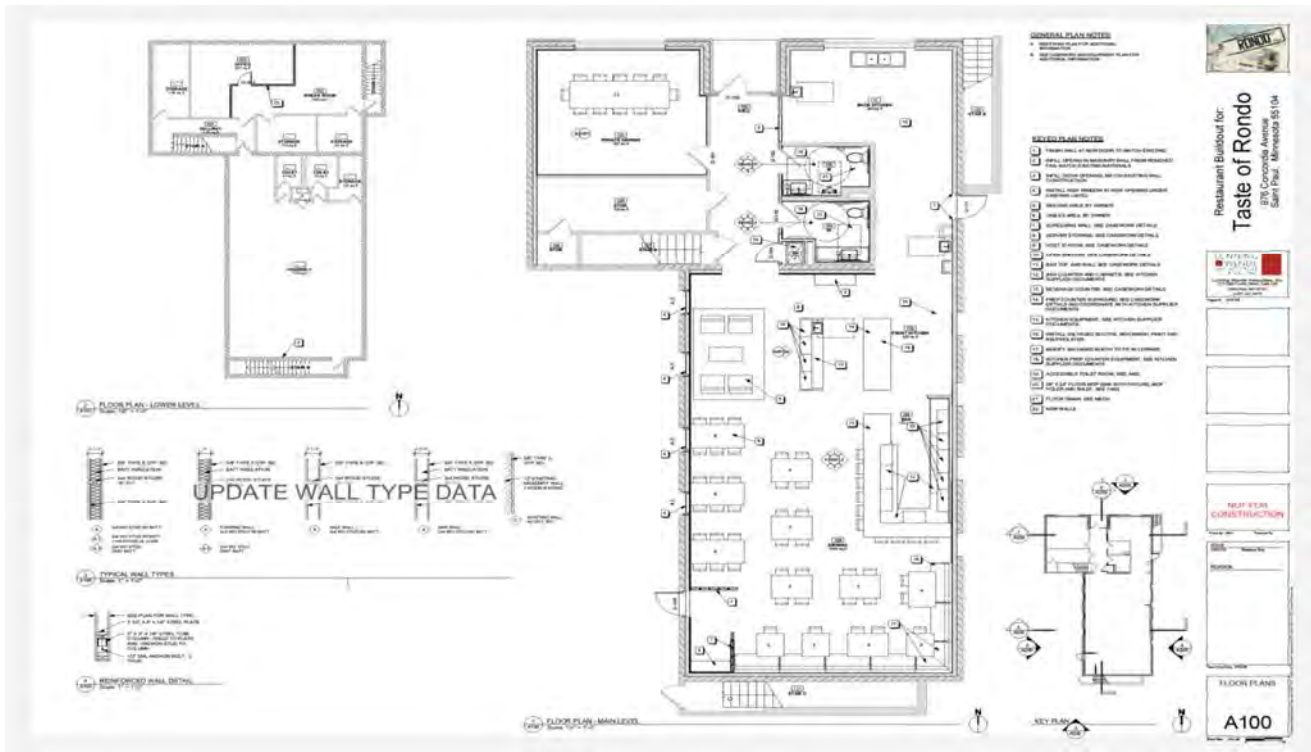

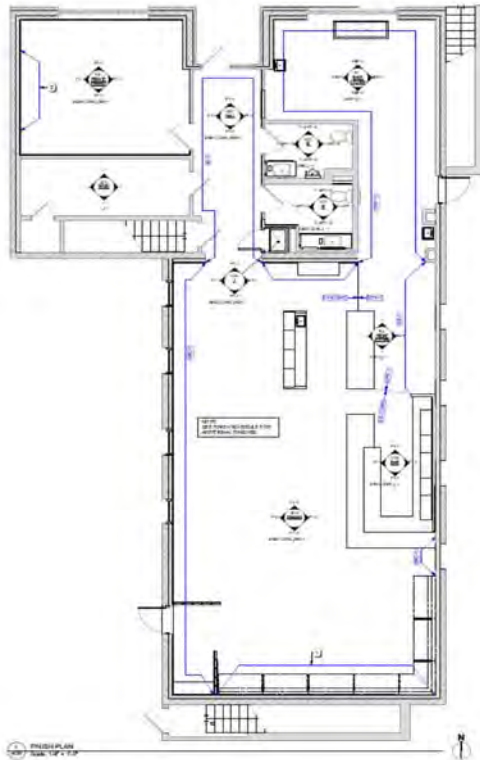

ROOM FRESH SCHEDULE

SEE EXHIBIT 10 FOR MEASUREMENTS OF EQUIPMENT FOOTPRINTS.

Number	Name	Model	Width	Depth	Height	Notes
1	FRIDGE	REF-1000	48"	24"	84"	ST-10
2	FRIDGE	REF-1000	48"	24"	84"	ST-11
3	FRIDGE	REF-1000	48"	24"	84"	ST-12
4	FRIDGE	REF-1000	48"	24"	84"	ST-13
5	FRIDGE	REF-1000	48"	24"	84"	ST-14
6	FRIDGE	REF-1000	48"	24"	84"	ST-15
7	FRIDGE	REF-1000	48"	24"	84"	ST-16
8	FRIDGE	REF-1000	48"	24"	84"	ST-17
9	FRIDGE	REF-1000	48"	24"	84"	ST-18
10	FRIDGE	REF-1000	48"	24"	84"	ST-19
11	FRIDGE	REF-1000	48"	24"	84"	ST-20
12	FRIDGE	REF-1000	48"	24"	84"	ST-21
13	FRIDGE	REF-1000	48"	24"	84"	ST-22
14	FRIDGE	REF-1000	48"	24"	84"	ST-23
15	FRIDGE	REF-1000	48"	24"	84"	ST-24
16	FRIDGE	REF-1000	48"	24"	84"	ST-25
17	FRIDGE	REF-1000	48"	24"	84"	ST-26
18	FRIDGE	REF-1000	48"	24"	84"	ST-27
19	FRIDGE	REF-1000	48"	24"	84"	ST-28
20	FRIDGE	REF-1000	48"	24"	84"	ST-29
21	FRIDGE	REF-1000	48"	24"	84"	ST-30
22	FRIDGE	REF-1000	48"	24"	84"	ST-31
23	FRIDGE	REF-1000	48"	24"	84"	ST-32
24	FRIDGE	REF-1000	48"	24"	84"	ST-33
25	FRIDGE	REF-1000	48"	24"	84"	ST-34
26	FRIDGE	REF-1000	48"	24"	84"	ST-35
27	FRIDGE	REF-1000	48"	24"	84"	ST-36
28	FRIDGE	REF-1000	48"	24"	84"	ST-37
29	FRIDGE	REF-1000	48"	24"	84"	ST-38
30	FRIDGE	REF-1000	48"	24"	84"	ST-39
31	FRIDGE	REF-1000	48"	24"	84"	ST-40
32	FRIDGE	REF-1000	48"	24"	84"	ST-41
33	FRIDGE	REF-1000	48"	24"	84"	ST-42
34	FRIDGE	REF-1000	48"	24"	84"	ST-43
35	FRIDGE	REF-1000	48"	24"	84"	ST-44
36	FRIDGE	REF-1000	48"	24"	84"	ST-45
37	FRIDGE	REF-1000	48"	24"	84"	ST-46
38	FRIDGE	REF-1000	48"	24"	84"	ST-47
39	FRIDGE	REF-1000	48"	24"	84"	ST-48
40	FRIDGE	REF-1000	48"	24"	84"	ST-49
41	FRIDGE	REF-1000	48"	24"	84"	ST-50
42	FRIDGE	REF-1000	48"	24"	84"	ST-51
43	FRIDGE	REF-1000	48"	24"	84"	ST-52
44	FRIDGE	REF-1000	48"	24"	84"	ST-53
45	FRIDGE	REF-1000	48"	24"	84"	ST-54
46	FRIDGE	REF-1000	48"	24"	84"	ST-55
47	FRIDGE	REF-1000	48"	24"	84"	ST-56
48	FRIDGE	REF-1000	48"	24"	84"	ST-57
49	FRIDGE	REF-1000	48"	24"	84"	ST-58
50	FRIDGE	REF-1000	48"	24"	84"	ST-59
51	FRIDGE	REF-1000	48"	24"	84"	ST-60
52	FRIDGE	REF-1000	48"	24"	84"	ST-61
53	FRIDGE	REF-1000	48"	24"	84"	ST-62
54	FRIDGE	REF-1000	48"	24"	84"	ST-63
55	FRIDGE	REF-1000	48"	24"	84"	ST-64
56	FRIDGE	REF-1000	48"	24"	84"	ST-65
57	FRIDGE	REF-1000	48"	24"	84"	ST-66
58	FRIDGE	REF-1000	48"	24"	84"	ST-67
59	FRIDGE	REF-1000	48"	24"	84"	ST-68
60	FRIDGE	REF-1000	48"	24"	84"	ST-69
61	FRIDGE	REF-1000	48"	24"	84"	ST-70
62	FRIDGE	REF-1000	48"	24"	84"	ST-71
63	FRIDGE	REF-1000	48"	24"	84"	ST-72
64	FRIDGE	REF-1000	48"	24"	84"	ST-73
65	FRIDGE	REF-1000	48"	24"	84"	ST-74
66	FRIDGE	REF-1000	48"	24"	84"	ST-75
67	FRIDGE	REF-1000	48"	24"	84"	ST-76
68	FRIDGE	REF-1000	48"	24"	84"	ST-77
69	FRIDGE	REF-1000	48"	24"	84"	ST-78
70	FRIDGE	REF-1000	48"	24"	84"	ST-79
71	FRIDGE	REF-1000	48"	24"	84"	ST-80
72	FRIDGE	REF-1000	48"	24"	84"	ST-81
73	FRIDGE	REF-1000	48"	24"	84"	ST-82
74	FRIDGE	REF-1000	48"	24"	84"	ST-83
75	FRIDGE	REF-1000	48"	24"	84"	ST-84
76	FRIDGE	REF-1000	48"	24"	84"	ST-85
77	FRIDGE	REF-1000	48"	24"	84"	ST-86
78	FRIDGE	REF-1000	48"	24"	84"	ST-87
79	FRIDGE	REF-1000	48"	24"	84"	ST-88
80	FRIDGE	REF-1000	48"	24"	84"	ST-89
81	FRIDGE	REF-1000	48"	24"	84"	ST-90
82	FRIDGE	REF-1000	48"	24"	84"	ST-91
83	FRIDGE	REF-1000	48"	24"	84"	ST-92
84	FRIDGE	REF-1000	48"	24"	84"	ST-93
85	FRIDGE	REF-1000	48"	24"	84"	ST-94
86	FRIDGE	REF-1000	48"	24"	84"	ST-95
87	FRIDGE	REF-1000	48"	24"	84"	ST-96
88	FRIDGE	REF-1000	48"	24"	84"	ST-97
89	FRIDGE	REF-1000	48"	24"	84"	ST-98
90	FRIDGE	REF-1000	48"	24"	84"	ST-99
91	FRIDGE	REF-1000	48"	24"	84"	ST-100

SEE EXHIBIT 10 FOR MEASUREMENTS OF EQUIPMENT FOOTPRINTS.



Restaurant Buildout for:
Taste of Rondo
390 Concordia Avenue
Saint Paul, Minnesota 55104



NOT FOR CONSTRUCTION

FRESH PLAN AND SCHEDULE

A120



SEE EQUIPMENT AND DIMENSIONS NOTES
 SEE CASEWORK REF AND DIMENSIONS

UPDATE
 KITCHEN INFO

ADD CASEWORK REF &
 DIMENSIONS AND
 EQUIPMENT NOTES
 AND REF

CASEWORK AND EQUIPMENT PLAN
 TASTE OF RONDO



Restaurant Buildout for
Taste of Rondo
 970 Concordia Avenue
 Saint Paul, Minnesota 55104



Blank rectangular boxes for notes or specifications.

**NOT FOR
 CONSTRUCTION**

Blank rectangular boxes for notes or specifications.

CASEWORK
 AND
 EQUIPMENT
 PLAN
A130

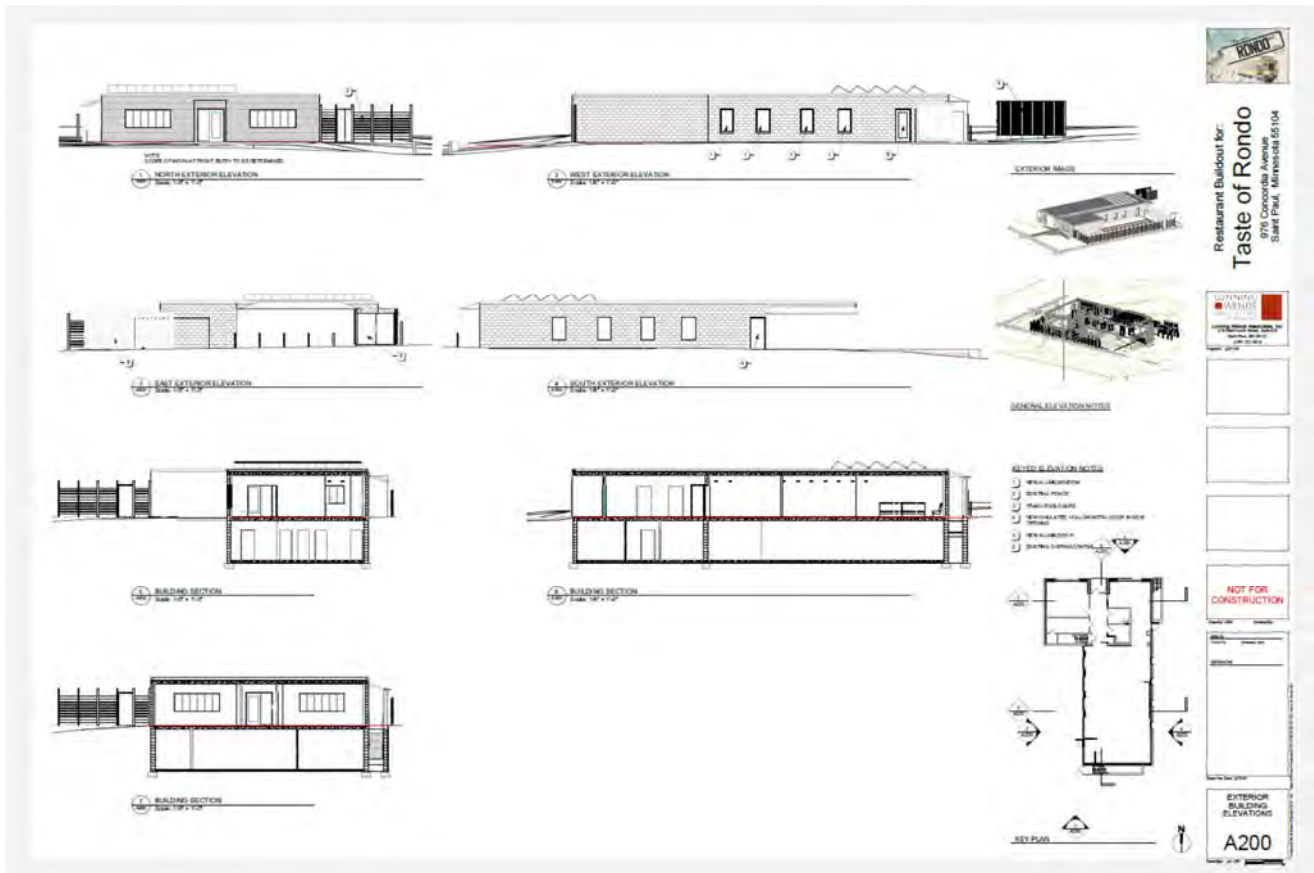

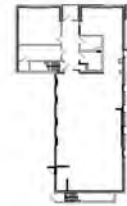

KEY PLAN

RONDO

Restaurant Buildout for
Taste of Rondo
 970 Concordia Avenue
 Saint Paul, Minnesota 55104

STANTEC
 ARCHITECTURE
 1000 Grand Avenue, Suite 1000
 St. Paul, MN 55102
 Phone: 612.222.1234
 Fax: 612.222.1235
 www.stantec.com

NOT FOR CONSTRUCTION

DATE: 08/14/14

PROJECT NO: 14-0000

INTERIOR IMAGES

A400

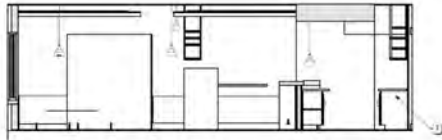

WEST WALL INTERIOR ELEVATION AT DINING ROOM
Elev. 10'-7 1/2"

GENERAL INTERIOR ELEVATION NOTES

WEST INTERIOR ELEVATION NOTES

1. SEE

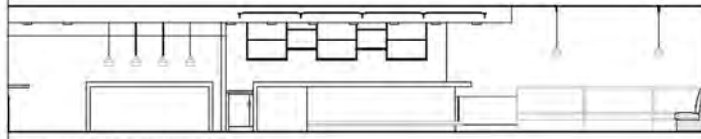

EAST INTERIOR ELEVATION AT DINING ROOM
Elev. 10'-7 1/2"

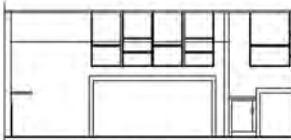

DINING ROOM ELEVATION
Elev. 10'-7 1/2"

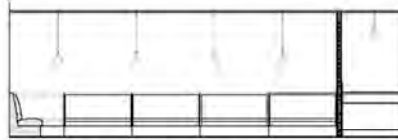

SOUTH INTERIOR ELEVATION AT DINING ROOM
Elev. 10'-7 1/2"

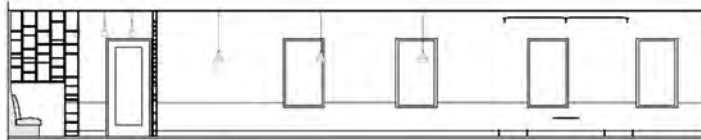

WEST INTERIOR ELEVATION AT DINING ROOM
Elev. 10'-7 1/2"

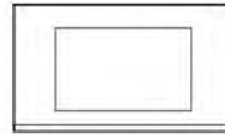

EAST INTERIOR ELEVATION AT DINING ROOM
Elev. 10'-7 1/2"



Restaurant Ballroom for
Taste of Rondo
976 Concordia Avenue
Saint Paul, Minnesota 55104



NOT FOR CONSTRUCTION

DATE: 10/1/12

SCALE: 1/8" = 1'-0"

PROJECT: TASTE OF RONDO RESTAURANT

ARCHITECT: [Redacted]

DATE: 10/1/12

SCALE: 1/8" = 1'-0"

PROJECT: TASTE OF RONDO RESTAURANT

ARCHITECT: [Redacted]

DATE: 10/1/12

SCALE: 1/8" = 1'-0"

PROJECT: TASTE OF RONDO RESTAURANT

ARCHITECT: [Redacted]

DATE: 10/1/12

SCALE: 1/8" = 1'-0"

PROJECT: TASTE OF RONDO RESTAURANT

ARCHITECT: [Redacted]

DATE: 10/1/12

SCALE: 1/8" = 1'-0"

PROJECT: TASTE OF RONDO RESTAURANT

ARCHITECT: [Redacted]

DATE: 10/1/12

SCALE: 1/8" = 1'-0"

PROJECT: TASTE OF RONDO RESTAURANT

ARCHITECT: [Redacted]

DATE: 10/1/12

SCALE: 1/8" = 1'-0"

PROJECT: TASTE OF RONDO RESTAURANT

ARCHITECT: [Redacted]

DATE: 10/1/12

SCALE: 1/8" = 1'-0"

PROJECT: TASTE OF RONDO RESTAURANT

ARCHITECT: [Redacted]

DATE: 10/1/12

SCALE: 1/8" = 1'-0"

PROJECT: TASTE OF RONDO RESTAURANT

ARCHITECT: [Redacted]

DATE: 10/1/12

SCALE: 1/8" = 1'-0"

PROJECT: TASTE OF RONDO RESTAURANT

ARCHITECT: [Redacted]

DATE: 10/1/12

SCALE: 1/8" = 1'-0"

PROJECT: TASTE OF RONDO RESTAURANT

ARCHITECT: [Redacted]

DATE: 10/1/12

SCALE: 1/8" = 1'-0"

PROJECT: TASTE OF RONDO RESTAURANT

ARCHITECT: [Redacted]

DATE: 10/1/12

SCALE: 1/8" = 1'-0"

PROJECT: TASTE OF RONDO RESTAURANT

ARCHITECT: [Redacted]

DATE: 10/1/12

SCALE: 1/8" = 1'-0"

PROJECT: TASTE OF RONDO RESTAURANT

ARCHITECT: [Redacted]

DATE: 10/1/12

SCALE: 1/8" = 1'-0"

PROJECT: TASTE OF RONDO RESTAURANT

ARCHITECT: [Redacted]

DATE: 10/1/12

SCALE: 1/8" = 1'-0"

PROJECT: TASTE OF RONDO RESTAURANT

ARCHITECT: [Redacted]

DATE: 10/1/12

SCALE: 1/8" = 1'-0"

PROJECT: TASTE OF RONDO RESTAURANT

ARCHITECT: [Redacted]

DATE: 10/1/12

SCALE: 1/8" = 1'-0"

PROJECT: TASTE OF RONDO RESTAURANT

ARCHITECT: [Redacted]

DATE: 10/1/12

SCALE: 1/8" = 1'-0"

PROJECT: TASTE OF RONDO RESTAURANT

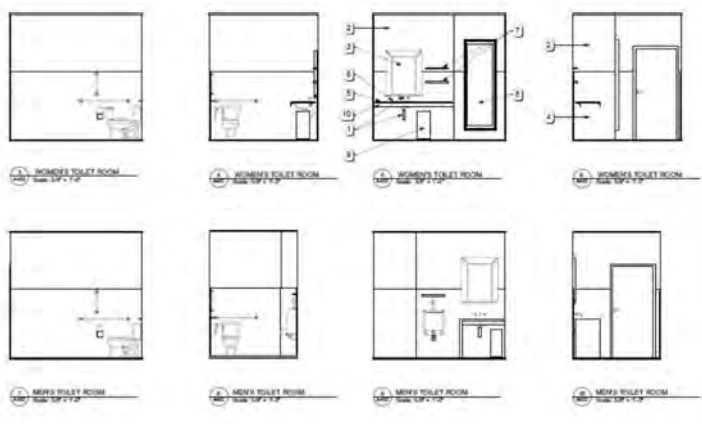
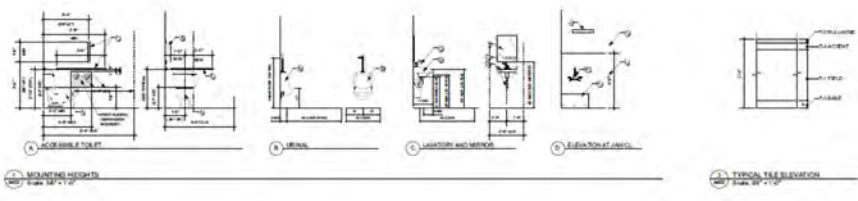

RESTROOMING HEIGHTS

GENERAL TOILET ROOM NOTES

- TOILET ROOM FINISHES**
- 1 ACCESSIBLE TOILET WITH SEATED TOILETING
 - 2 MEN'S TOILET
 - 3 MEN'S TOILET WITH SEATED TOILETING
 - 4 MEN'S TOILET WITH SEATED TOILETING AND URINAL
 - 5 MEN'S TOILET WITH SEATED TOILETING AND URINAL AND MIRROR
 - 6 MEN'S TOILET WITH SEATED TOILETING AND URINAL AND MIRROR AND VENTILATION
 - 7 MEN'S TOILET WITH SEATED TOILETING AND URINAL AND MIRROR AND VENTILATION AND MIRROR
 - 8 MEN'S TOILET WITH SEATED TOILETING AND URINAL AND MIRROR AND VENTILATION AND MIRROR AND MIRROR
 - 9 MEN'S TOILET WITH SEATED TOILETING AND URINAL AND MIRROR AND VENTILATION AND MIRROR AND MIRROR AND MIRROR
 - 10 MEN'S TOILET WITH SEATED TOILETING AND URINAL AND MIRROR AND VENTILATION AND MIRROR AND MIRROR AND MIRROR AND MIRROR

RONDO

Restaurant Buildout for
Taste of Rondo
970 Concordia Avenue
Saint Paul, Minnesota 55104

NOT FOR CONSTRUCTION

INTERIOR ELEVATIONS AT TOILET ROOMS

A402

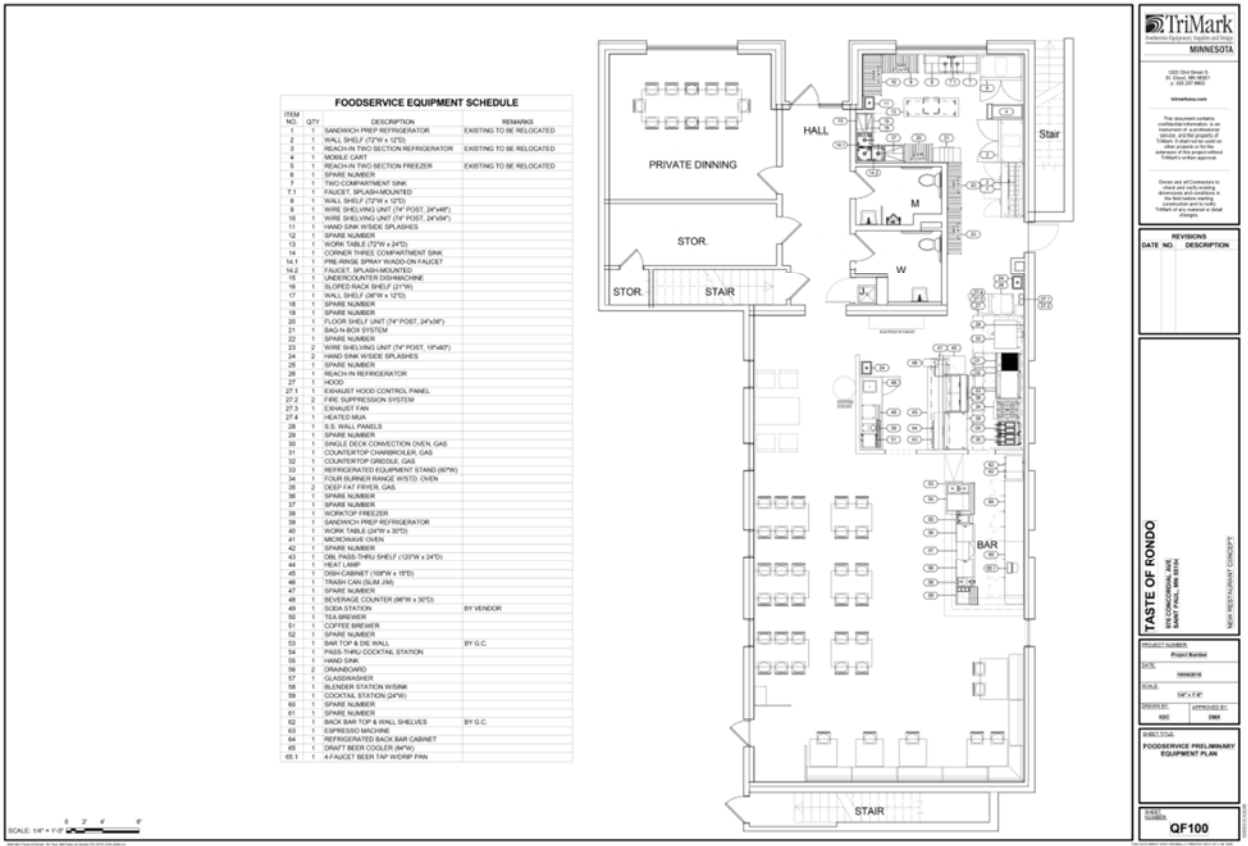

FOODSERVICE EQUIPMENT SCHEDULE			
ITEM NO.	QTY	DESCRIPTION	REMARKS
1	1	SANDWICH PREP REFRIGERATOR	EXISTING TO BE RELOCATED
2	1	WALL SHELF (2'W x 12')	
3	1	REACH-IN TWO SECTION REFRIGERATOR	EXISTING TO BE RELOCATED
4	1	MOBILE CART	
5	1	REACH-IN TWO SECTION FREEZER	EXISTING TO BE RELOCATED
6	1	SPARE NUMBER	
7	1	TWO COMPARTMENT SINK	
7.1	1	FAUCET, SPASH-MOUNTED	
8	1	WALL SHELF (2'W x 12')	
9	1	WIRE SHELVING UNIT (4" POST, 24"SP)	
10	1	WIRE SHELVING UNIT (4" POST, 24"SP)	
11	1	HAND SINK W/SH. SPLASHES	
12	1	SPARE NUMBER	
13	1	WORK TABLE (2'W x 24')	
14	1	CORNER THREE COMPARTMENT SINK	
14.1	1	PRE-RINSE SPRAY WASH-ON FAUCET	
14.2	1	FAUCET, SPASH-MOUNTED	
15	1	UNDERCOUNTER DISHWASHER	
16	1	SLOPED BACK SHELF (3'W)	
17	1	WALL SHELF (2'W x 12')	
18	1	SPARE NUMBER	
19	1	SPARE NUMBER	
20	1	FLOOR SHELF UNIT (4" POST, 24"SP)	
21	1	SAG-A-BOX SYSTEM	
22	1	SPARE NUMBER	
23	2	WIRE SHELVING UNIT (4" POST, 18"SP)	
24	2	HAND SINK W/SH. SPLASHES	
25	1	SPARE NUMBER	
26	1	REACH-IN REFRIGERATOR	
27	1	HOOD	
27.1	1	EXHAUST HOOD CONTROL PANEL	
27.2	1	FIRE SUPPRESSION SYSTEM	
27.3	1	EXHAUST FAN	
27.4	1	HEATED MUA	
28	1	S.S. WALL PANELS	
29	1	SPARE NUMBER	
30	1	SINGLE DECK CONVECTION OVEN GAS	
31	1	COUNTERTOP CONVECTROLER GAS	
32	1	COUNTERTOP GRIDDLE GAS	
33	1	REFRIGERATED EQUIPMENT STAND (8'W)	
34	1	FOUR BURNER RANGE W/ST. OVEN	
35	2	DEEP FAT FRYER GAS	
36	1	SPARE NUMBER	
37	1	SPARE NUMBER	
38	1	WORKTOP FREEZER	
39	1	SANDWICH PREP REFRIGERATOR	
40	1	WORK TABLE (2'W x 30')	
41	1	MICROWAVE OVEN	
42	1	SPARE NUMBER	
43	1	DEL. PASS THRU SHELF (2'W x 24')	
44	1	HEAT LAMP	
45	1	DRINK CABINET (18" W x 18")	
46	1	TRASH CAN (50L JMS)	
47	1	SPARE NUMBER	
48	1	BEVERAGE COUNTER (8'W x 3'0")	BY VENDOR
49	1	SOA STATION	
50	1	TEA BREWERY	
51	1	COFFEE BREWER	
52	1	SPARE NUMBER	
53	1	BAR TOP & DR. WALL	
54	1	PASS THRU COCKTAIL STATION	BY G.C.
55	1	HAND SINK	
56	2	DRINKBOARD	
57	1	GLASSWASHER	
58	1	BLENDER STATION W/SINK	
59	1	COCKTAIL STATION (24" W)	
60	1	SPARE NUMBER	
61	1	SPARE NUMBER	
62	1	BACK BAR TOP & WALL SHELVES	BY G.C.
63	1	ESPRESSO MACHINE	
64	1	REFRIGERATED BACK BAR CABINET	
65	1	DRAFT BEER COOLER (84" W)	
65.1	1	4 FAUCET BEER TAP W/DRIP PAN	

SCALE: 1/4" = 1'-0"

TriMark
MINNESOTA

1000 Oak Street S.
St. Paul, MN 55108
612.277.4800
www.trimark.com

This document is prepared by an individual or individuals who are not a duly licensed professional engineer or architect in the State of Minnesota. It is not intended to be used as such and its use is prohibited.

REVISIONS

DATE	NO.	DESCRIPTION

TASTE OF RONDO
1000 POND STREET
ST. PAUL, MN 55108
RESTAURANT CONCEPT

PROJECT NUMBER: Rondo-Restaur
SITE: MINNEAPOLIS
DATE: 04/11/11
PROJECT: 1000 POND ST.
REV: 001

DRAWN BY: JMM
CHECKED BY: JMM
DATE: 04/11/11





PROJECT: FOODSERVICE PRELIMINARY EQUIPMENT PLAN

SCALE: 1/4" = 1'-0"
QF100

CASEWORK
ELEVATIONS AND
DETAILS

DOOR SCHEDULE

UPDATE

- 
① WINDOW HEAD
Page 1 of 114
- 
② WINDOW JAMB
Page 1 of 114
- 
③ WINDOW SILL
Page 1 of 114
- 
④ TYPICAL WINDOW DETAILS
Page 1 of 114



Restaurant Blueprint for
Taste of Rondo
978 Concordia Avenue
Saint Paul, Minnesota 55104







DATE
SCALE
REVISIONS

DETAILS AND
OPENINGS
A500

[Sign In](#)

[Live Meetings](#)
[City Home](#)
[Research](#)
[Legislation](#)
[Calendar](#)
[City Council](#)
[Boards or Commissions](#)



[Share](#)

[RSS](#)

Details		Reports	
File #:	RES 18-1143	Version: 1	Name:
Type:	Resolution	Status:	Mayor's Office
		In control:	City Council
		Final action:	7/25/2018
Title:	Approving additional FY2018 Neighborhood Sales Tax Revitalization (STAR) loan and grant program awards.		
Sponsors:	Amy Brendmoen		
Attachments:	1. RES #18-1143 2018 Neighborhood STAR Financial Analysis 7-10-18		
History (1)		Text	
		Public Comments (0)	

Title
Approving additional FY2018 Neighborhood Sales Tax Revitalization (STAR) loan and grant program awards.

Body
WHEREAS, on September 28, 1994, the City Council of the City of Saint Paul established the Neighborhood Sales Tax Revitalization (STAR) Program, C.F. 94-1127; and

WHEREAS, the Neighborhood STAR Program is financed in accordance with Minnesota Statutes, Chapter 297A, authorized by the State of Minnesota, Chapter No. 375, Sec.46; and

WHEREAS, the purpose of the Neighborhood STAR Program is to fund capital improvements to further residential, commercial and economic development in the neighborhoods of Saint Paul; and

WHEREAS, input into the review and selection process was solicited from the Planning Commission, Capital Improvement Budget Committee, and city staff; now therefore be it

RESOLVED, upon the recommendation of the Mayor, and with the advice of the Neighborhood STAR Board, the Council of the City of Saint Paul hereby approves funding for the twenty-five (25) 2018 Neighborhood STAR Loan and Grant Program projects as identified in the attached Financial Analysis; and be it

FURTHER RESOLVED, upon the recommendation of the Mayor, project, #18-136, Taste of Rondo Restaurant, is being recommended to receive up to a total of \$100,000 grant and a \$100,000 loan in the event Neighborhood STAR dollars are realized from one or more prior-year Neighborhood STAR projects completed under budget or not moving forward in 2018; and be it

FURTHER RESOLVED, implementation of all projects and programs identified for funding in the Twenty-Fourth Cycle Neighborhood STAR Large Loan and Grant Program shall conform to Part 6, Awards and Implementation of the Neighborhood STAR Guidelines as updated in February 2018; and be it

FINALLY RESOLVED, that the Mayor and City Council wish to extend their appreciation to the forty (40) Neighborhood STAR Program applicants, and especially to Neighborhood STAR Board members for their commitment of time, talent, and efforts on behalf of the Neighborhood STAR Program and the City of Saint Paul.

<https://stpaul.legistar.com/LegislationDetail.aspx?ID=3557380&GUID=6ACFA781-87B3-4618-AF51-7A...> 7/30/2018

**RESOLUTION APPROVING THE USE OF GRANT FUNDS
THROUGH THE NEIGHBORHOOD STAR YEAR-ROUND PROGRAM
FOR THE TASTE OF RONDO PROJECT**

WHEREAS, on December 12, 2018, the Neighborhood STAR Board reviewed a proposal from the Taste of Rondo for grant financing through the Neighborhood STAR Year-Round Program to provide capital improvements to their project located at 976 Concordia Avenue; and

WHEREAS, the rehabilitation of this building into a new restaurant will positively impact the city's Rondo community; and

WHEREAS, the Neighborhood STAR Board rated this project a 4.5 on a scale from 1 (low) to 5 (high); and

WHEREAS, due to the proposal being of substantial community significance, a waiver to the Neighborhood STAR Guideline requiring a \$1 for \$1 private match is being recommended; and

WHEREAS, it is the intent of the Mayor and the Saint Paul City Council to participate in the financing of these activities by providing up to \$10,000 in grant financing through the Ward 1 Neighborhood STAR Year-Round Program; now be it

RESOLVED, upon the recommendation of the Mayor, the Council of the City of Saint Paul hereby authorizes and directs the appropriate City officials to execute the necessary grant documents to implement this Resolution, subject to approval by the City Attorney; and be it

FINALLY RESOLVED, staff of the Department of Planning and Economic Development are further authorized and directed to proceed with all other actions necessary to implement this Resolution.



CITY OF SAINT PAUL

DEPARTMENT OF SAFETY AND INSPECTIONS
Ricardo X. Cervantes, Director

375 Jackson Street, Suite 220
Saint Paul, Minnesota 55101-1806

Telephone: 651-266-8989
Facsimile: 651-266-9124
Web: www.stpaul.gov/dsi

April 5, 2018

To Whom It May Concern,

Preliminary information regarding the proposed establishment of a restaurant at 976 Concordia Avenue, Saint Paul MN 55104 has been provided to the City of Saint Paul, Department of Safety and Inspections by Mr. Charles Carter and his architectural consultant, Lunning Wende Associates, Inc. The information provided regarding the operation of the establishment appears to meet the definition of a "restaurant" as defined in Saint Paul Legislative Code Sec. 409.02. As such, Mr. Carter appears to be a viable applicant for a City of Saint Paul On-Sale Liquor – Restaurant License.

This letter should in no way be interpreted and/or read as pending and/or actual approval of any city-issued license or other authorization, but rather an acknowledgement that the preliminary information provided by Mr. Carter regarding his proposed plans for 976 Concordia Avenue make him a viable candidate to apply for a City of Saint Paul On-Sale Liquor – Restaurant License. Ultimate review, approval, and issuance of any such license would be fully dependent upon, at a minimum, the satisfaction of some or all of the following: city licensing, zoning, site plan, and fire safety requirements; applicable State approvals and authorizations; Director, Council, and Mayor approvals.

Please let me know if there are any questions.

Dan Niziolek
Deputy Director
Department of Safety and Inspections